

1

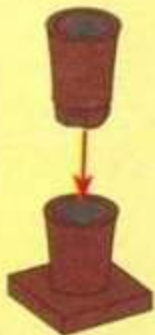

2



3

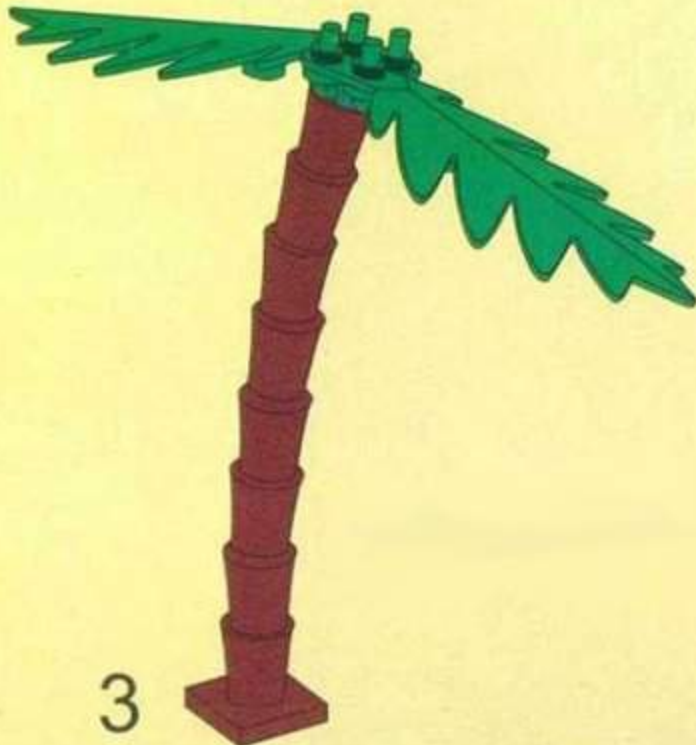

4



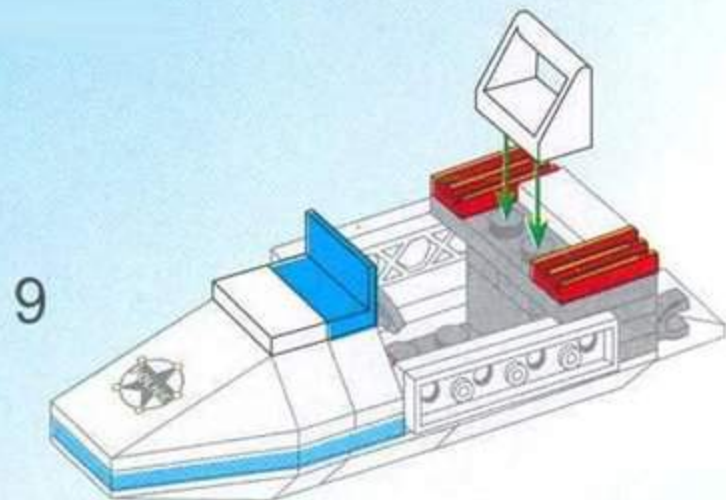
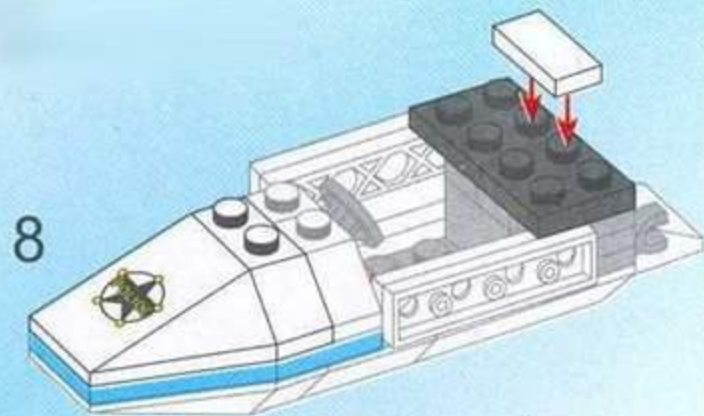
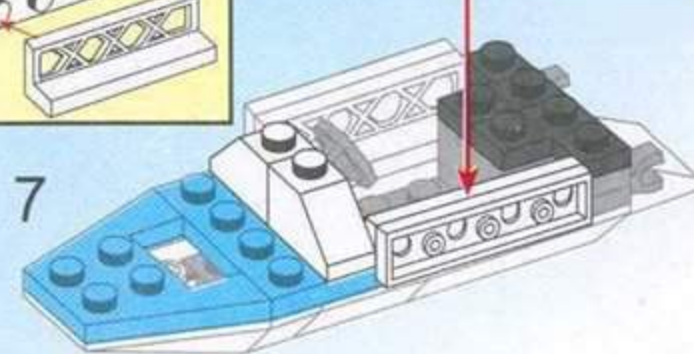
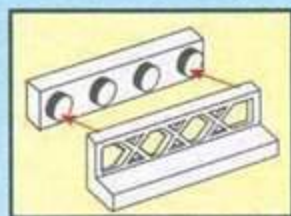
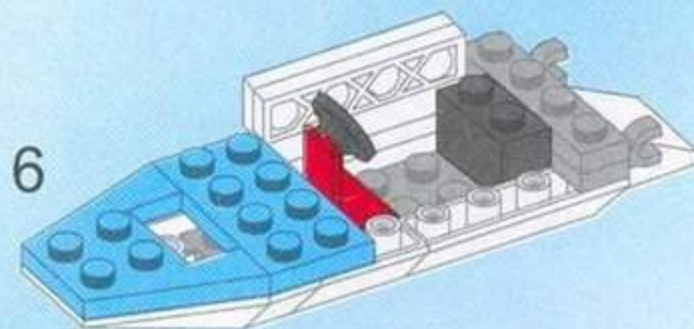
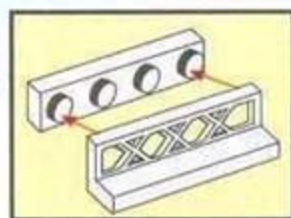
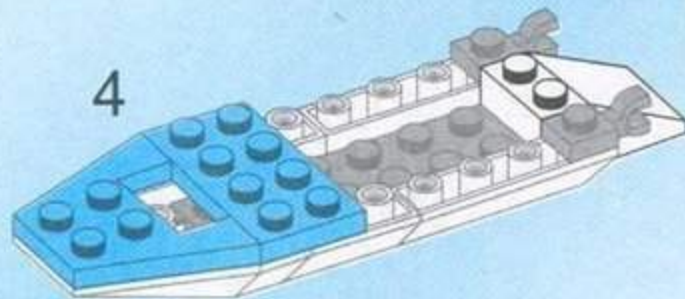
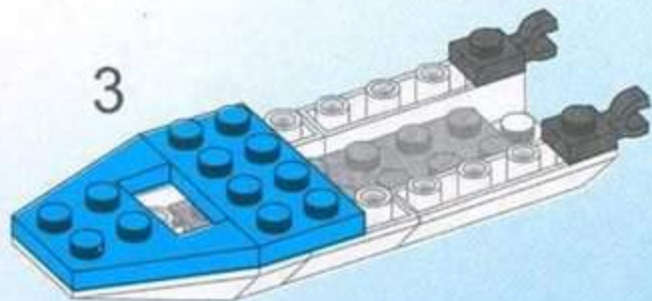
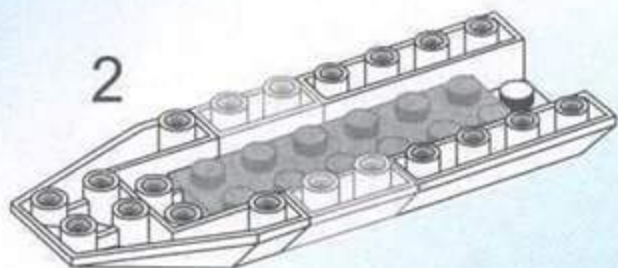
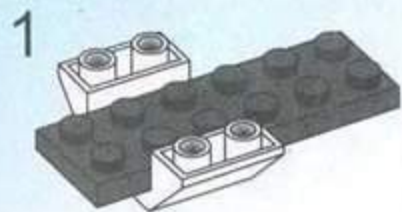

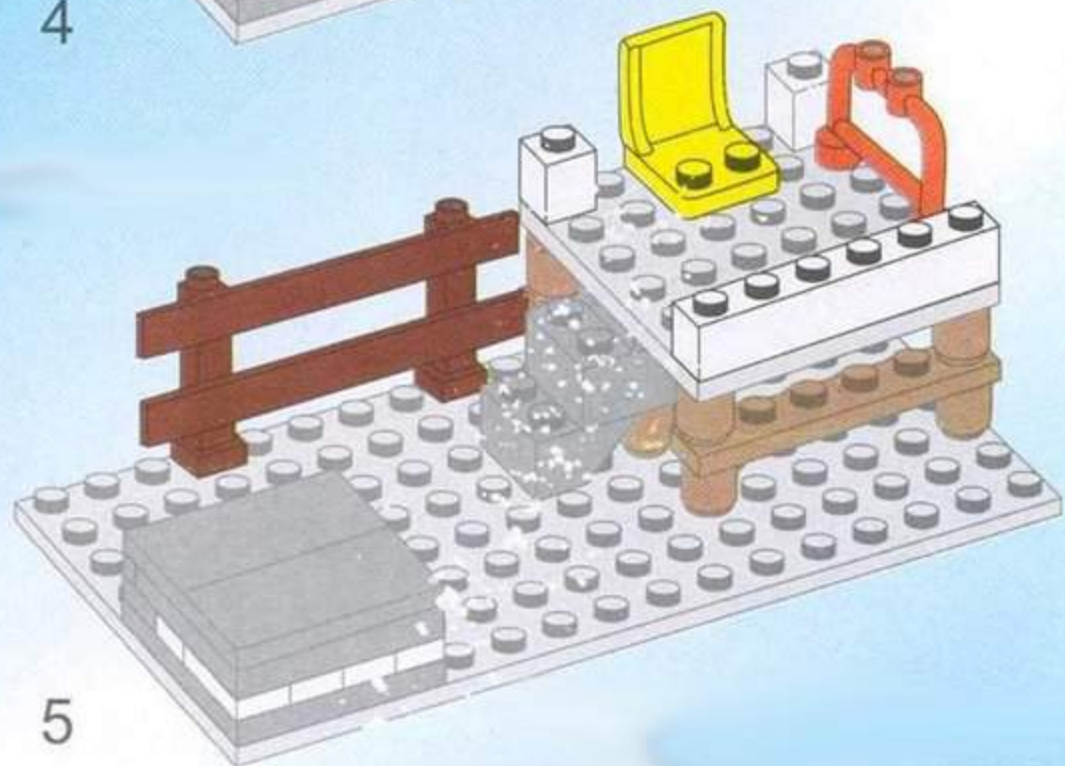
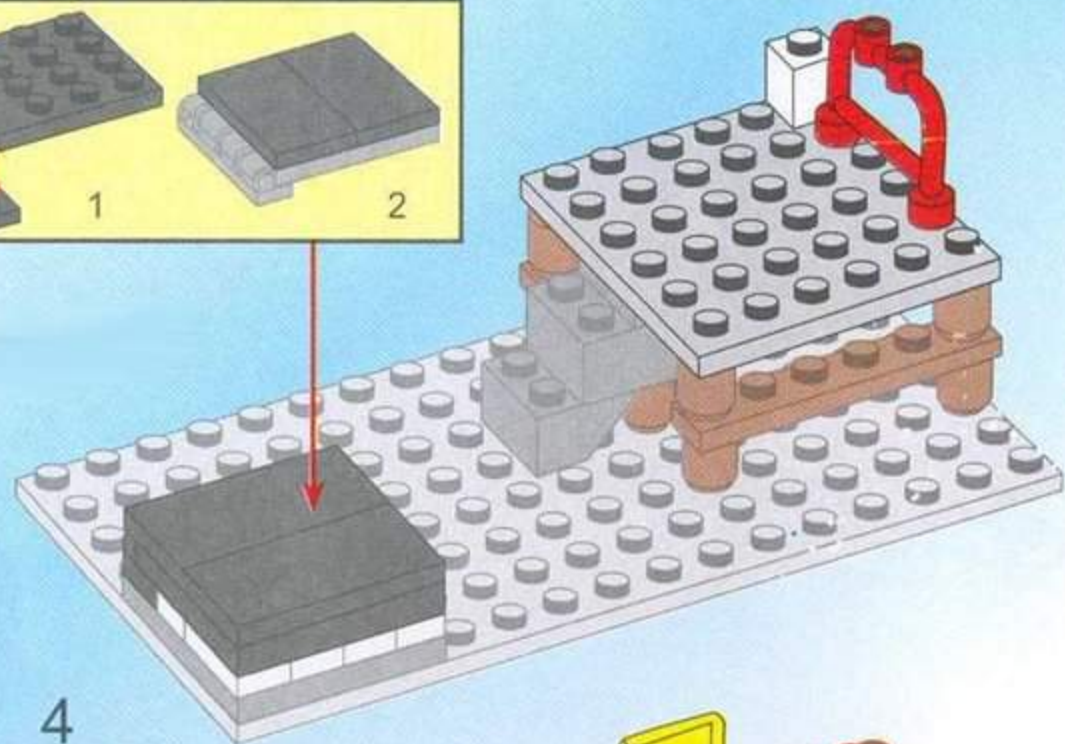
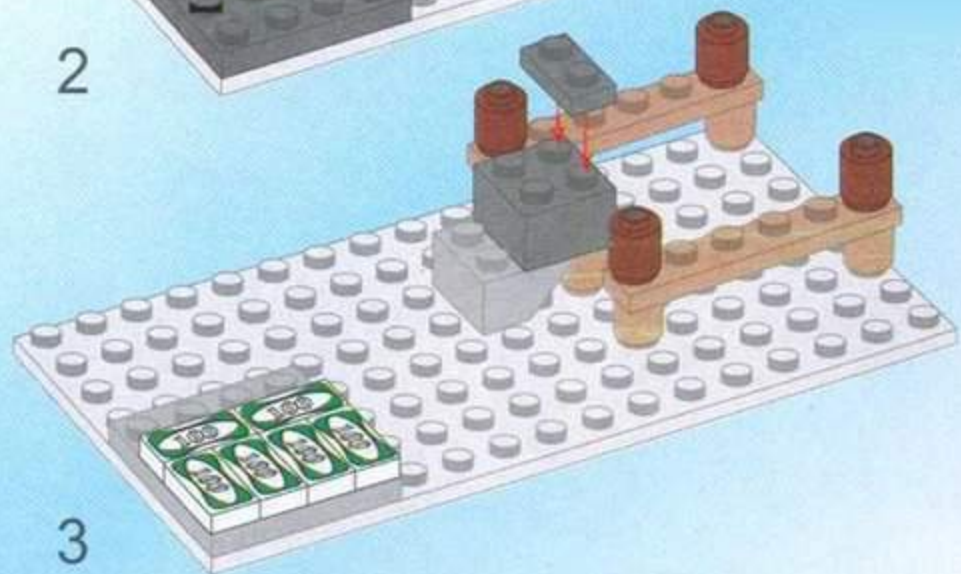
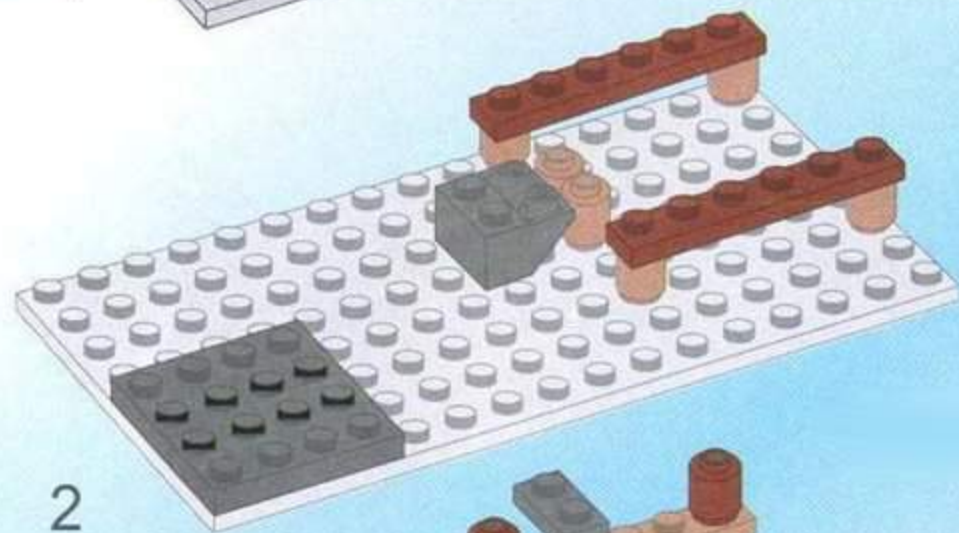
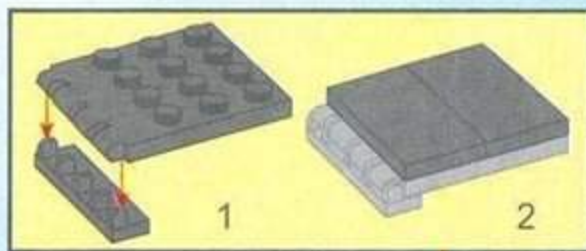
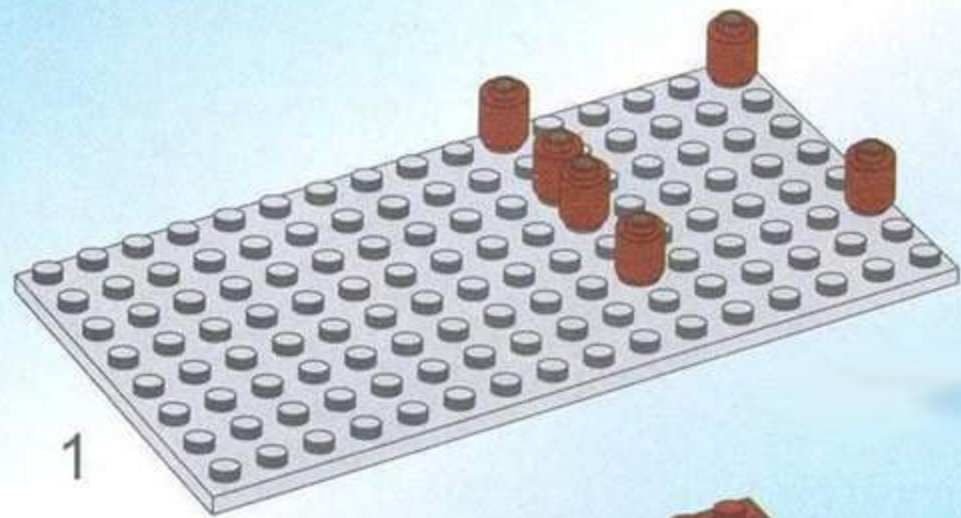

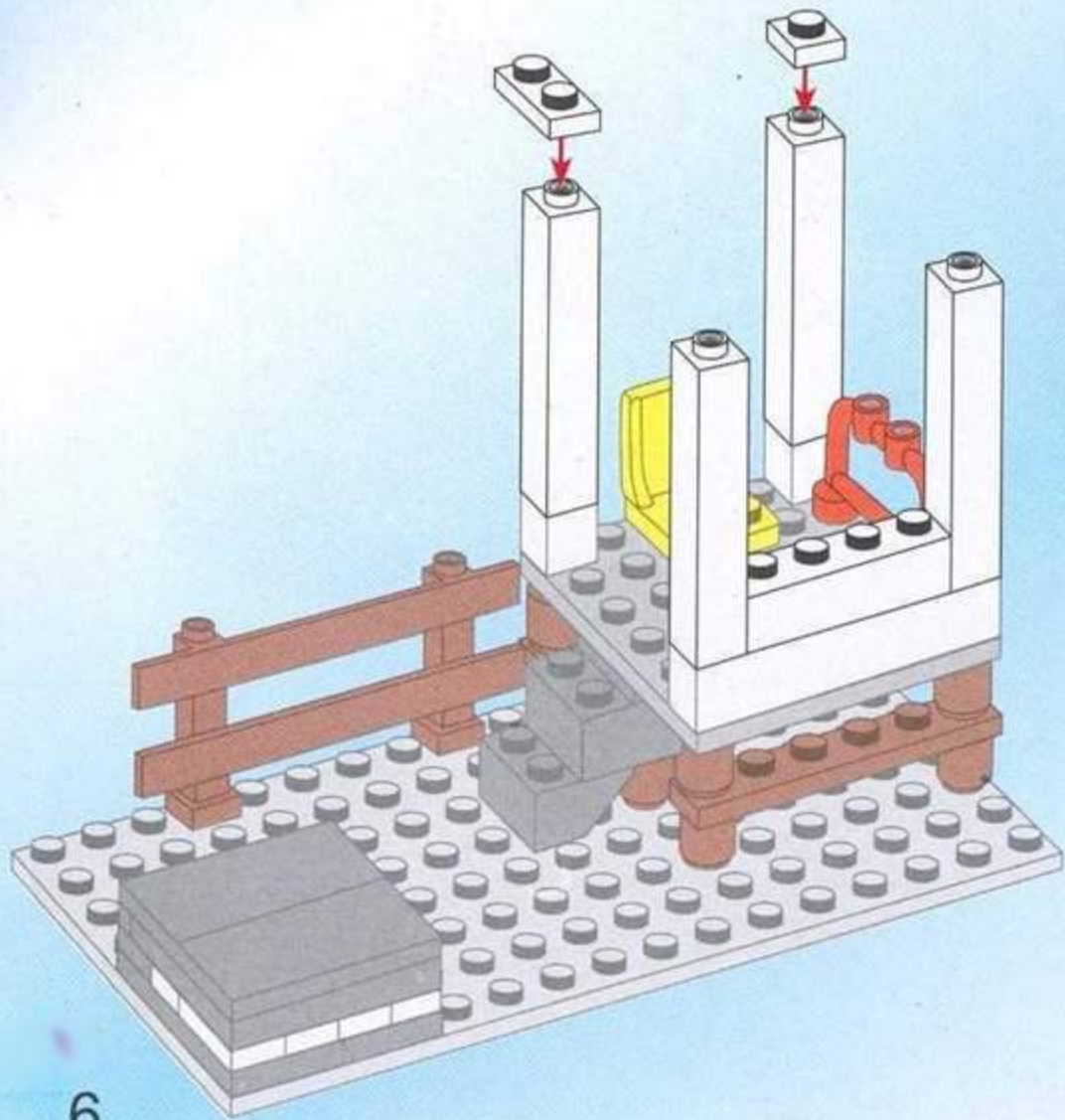

6

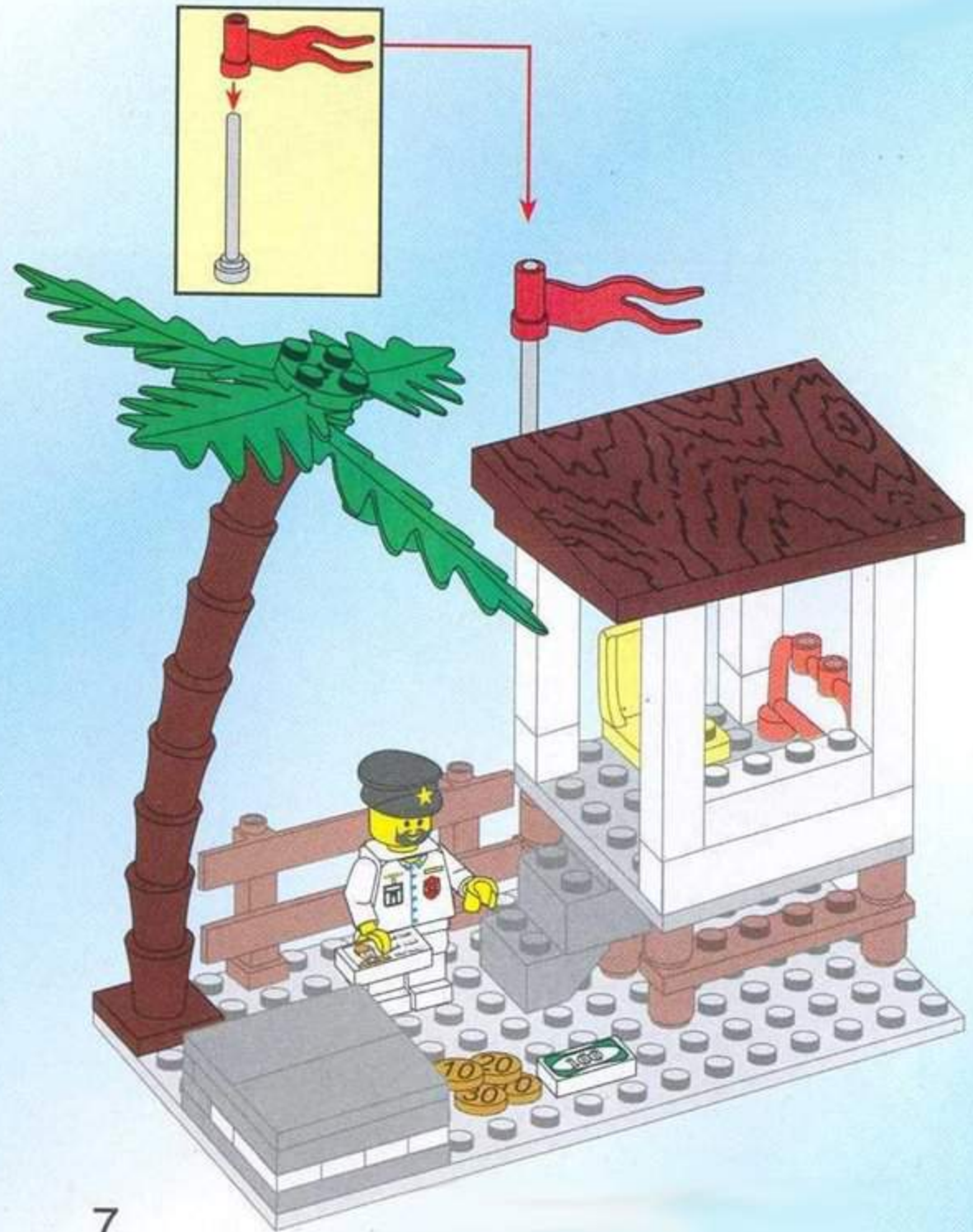

7

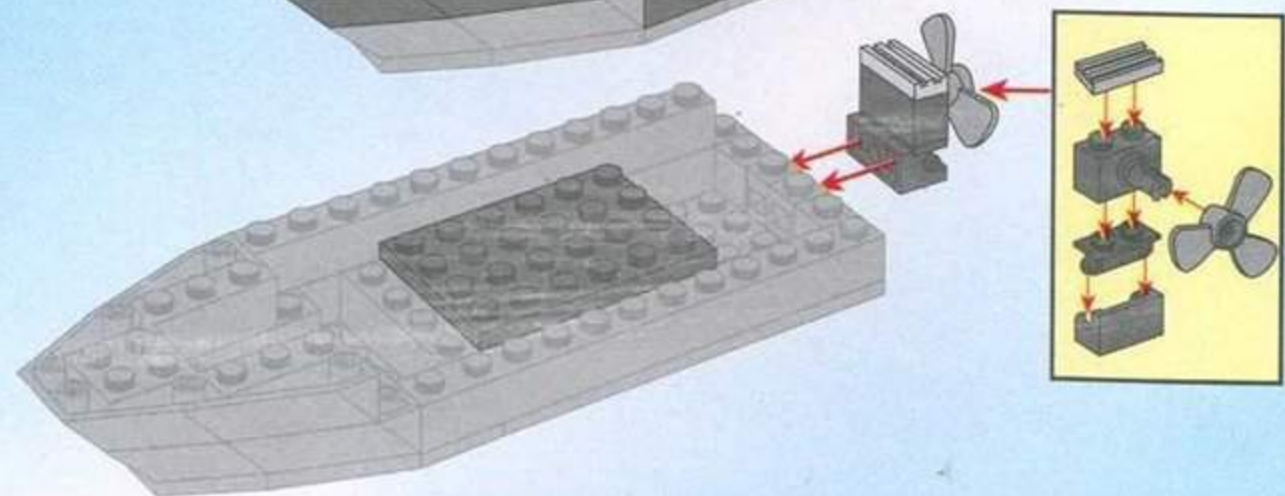
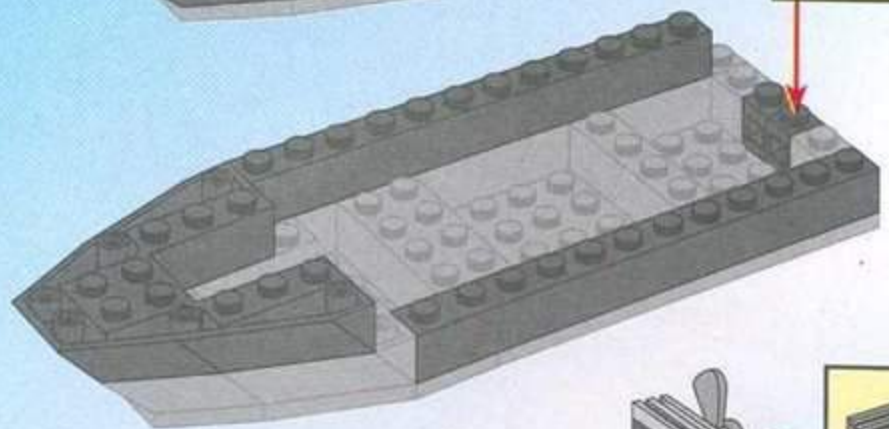
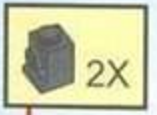
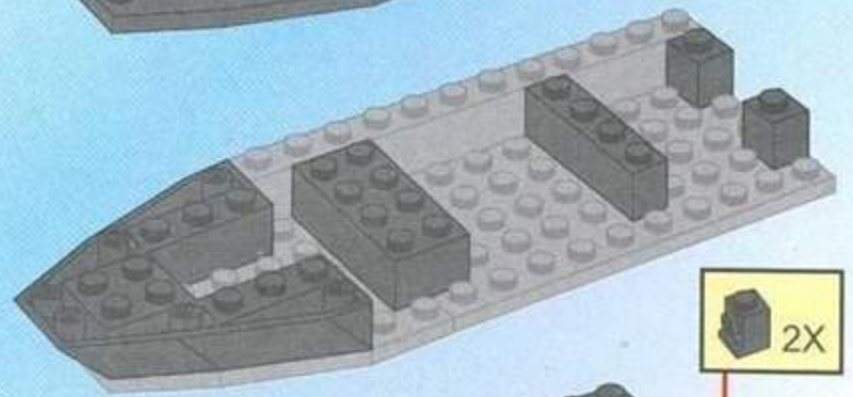
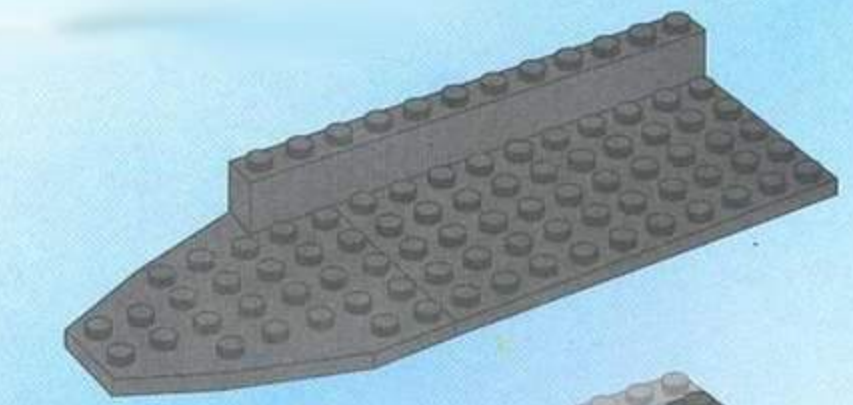
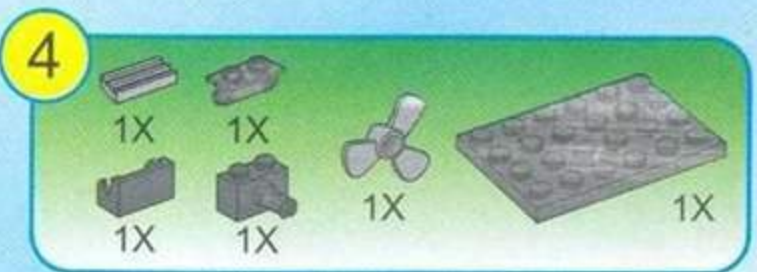
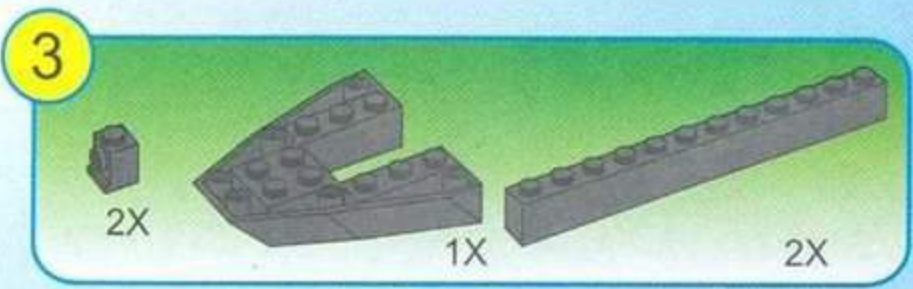
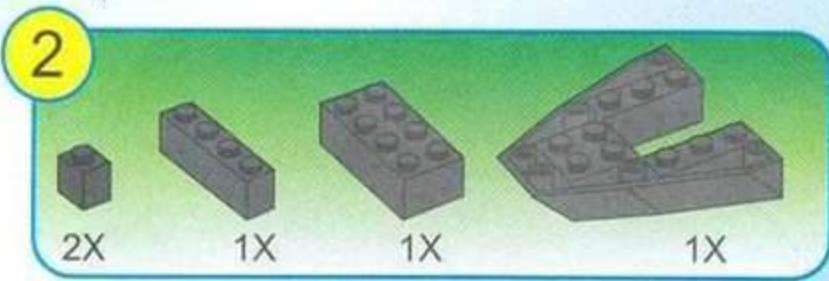
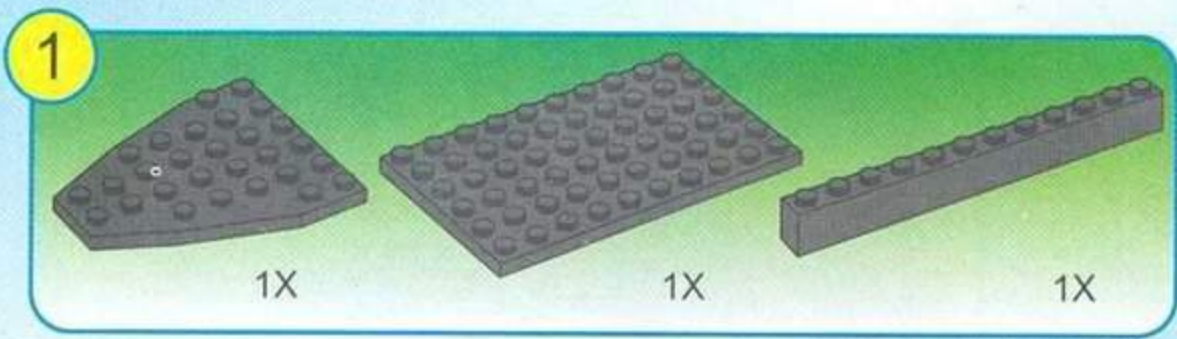

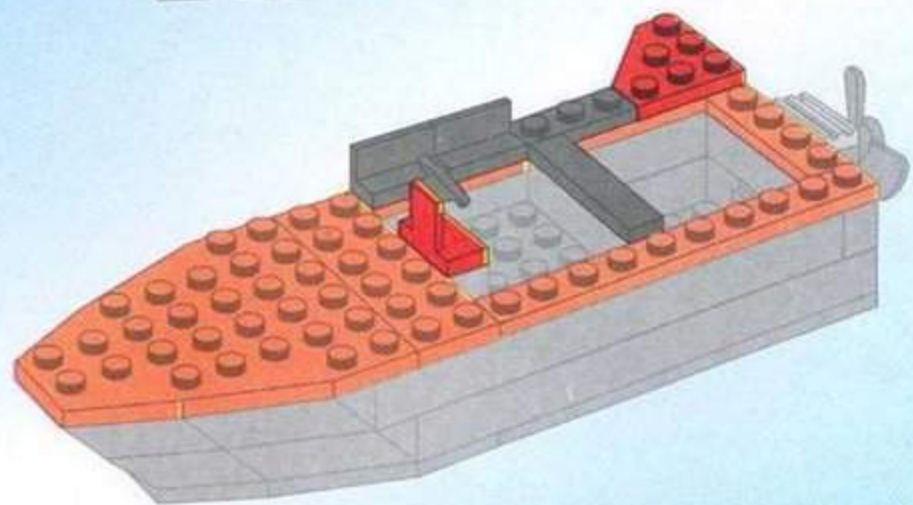
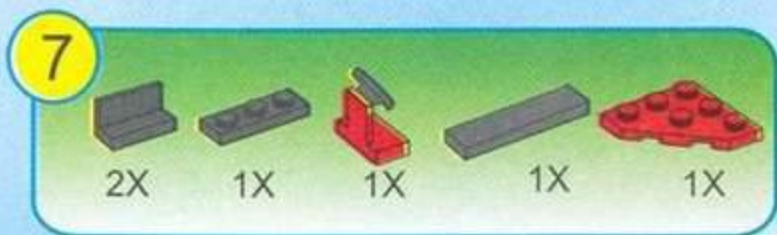
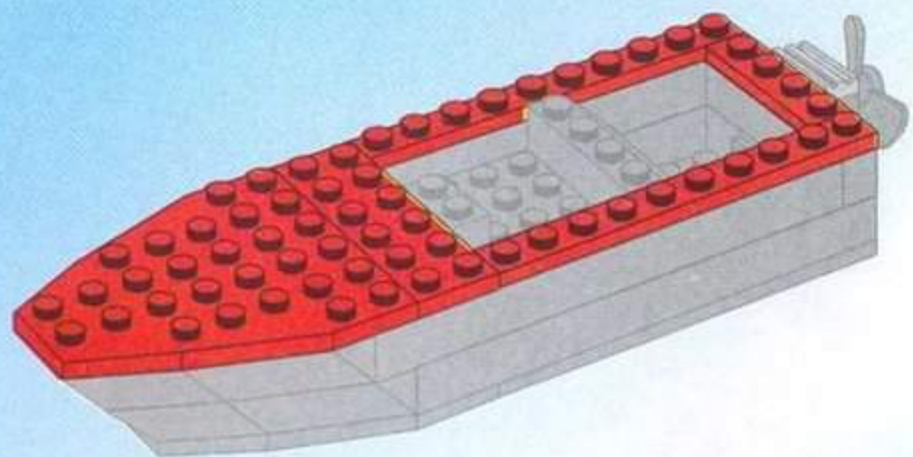
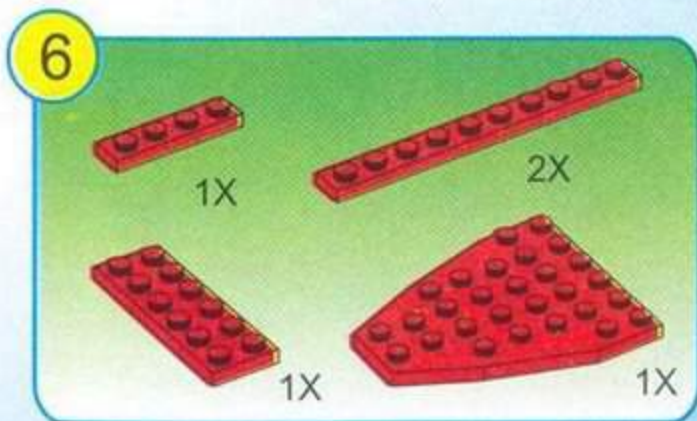
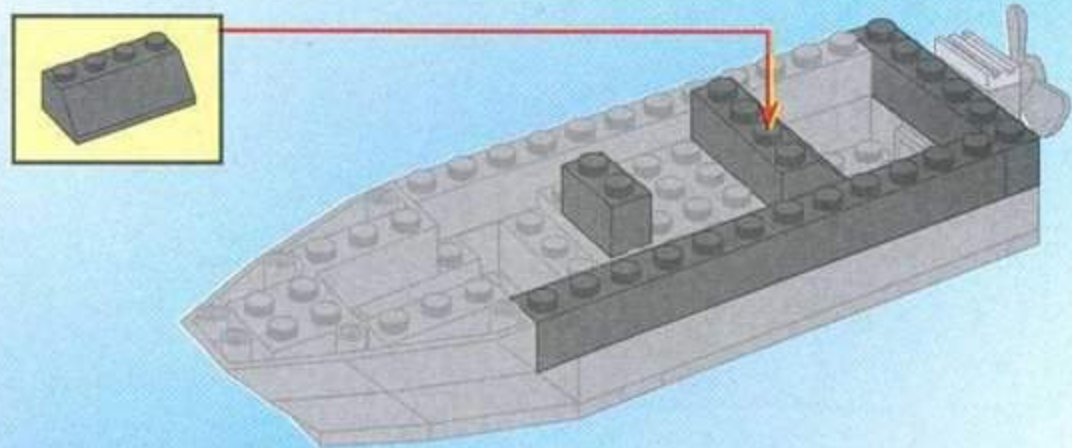
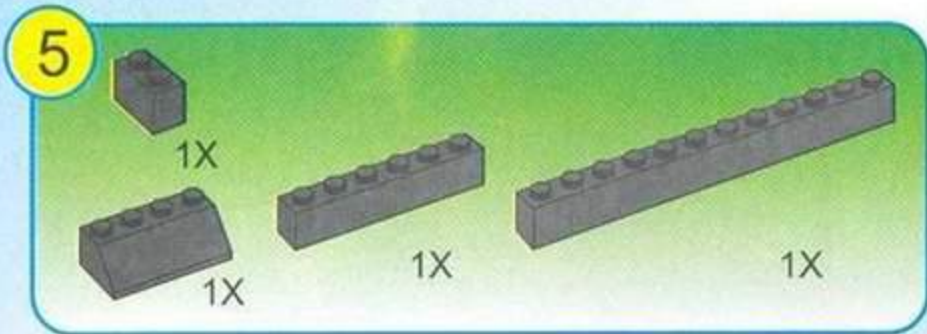

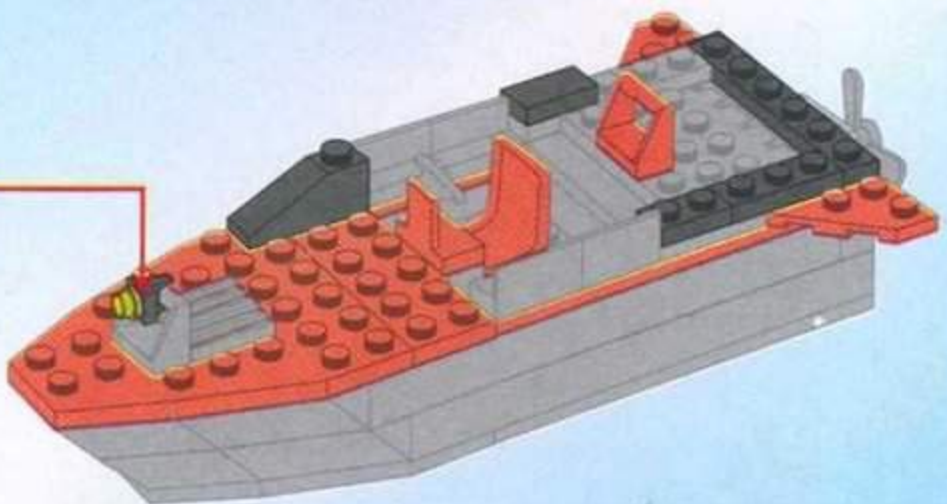
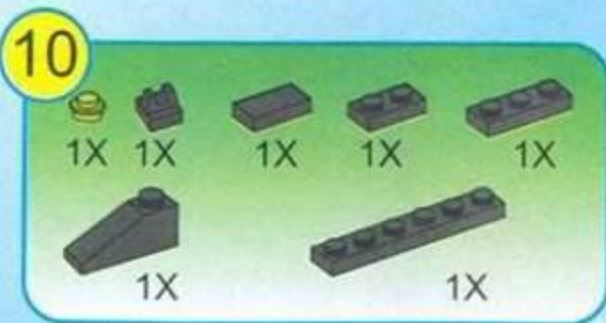
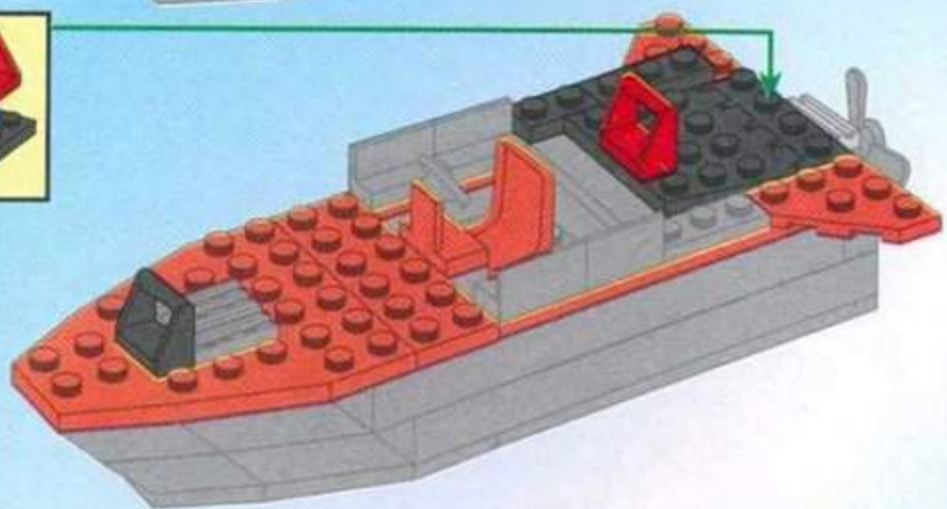
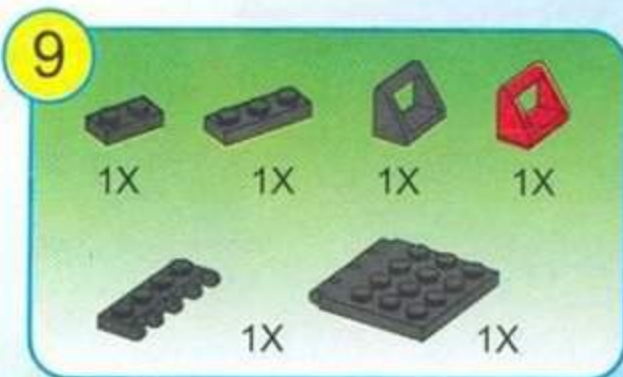
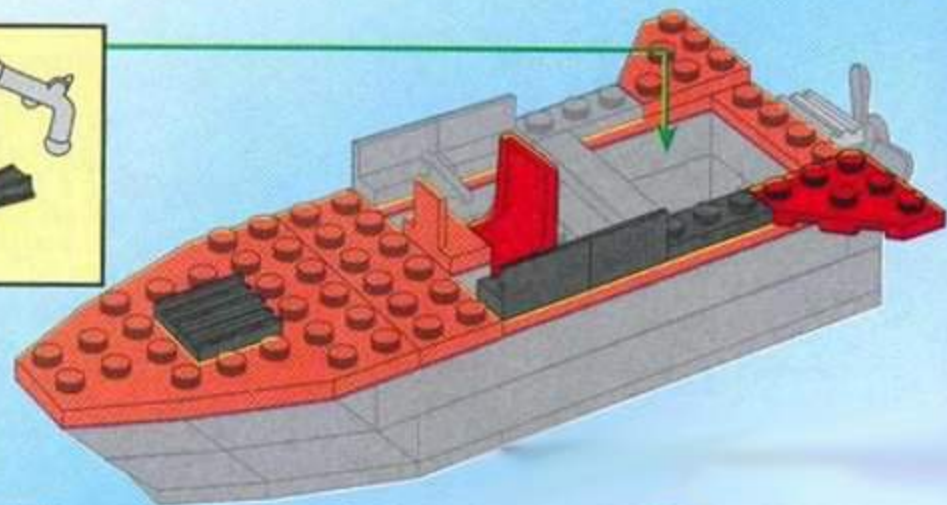
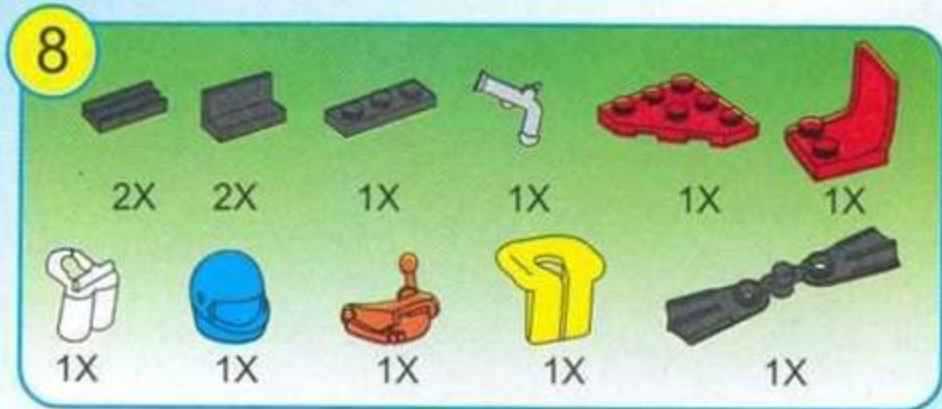

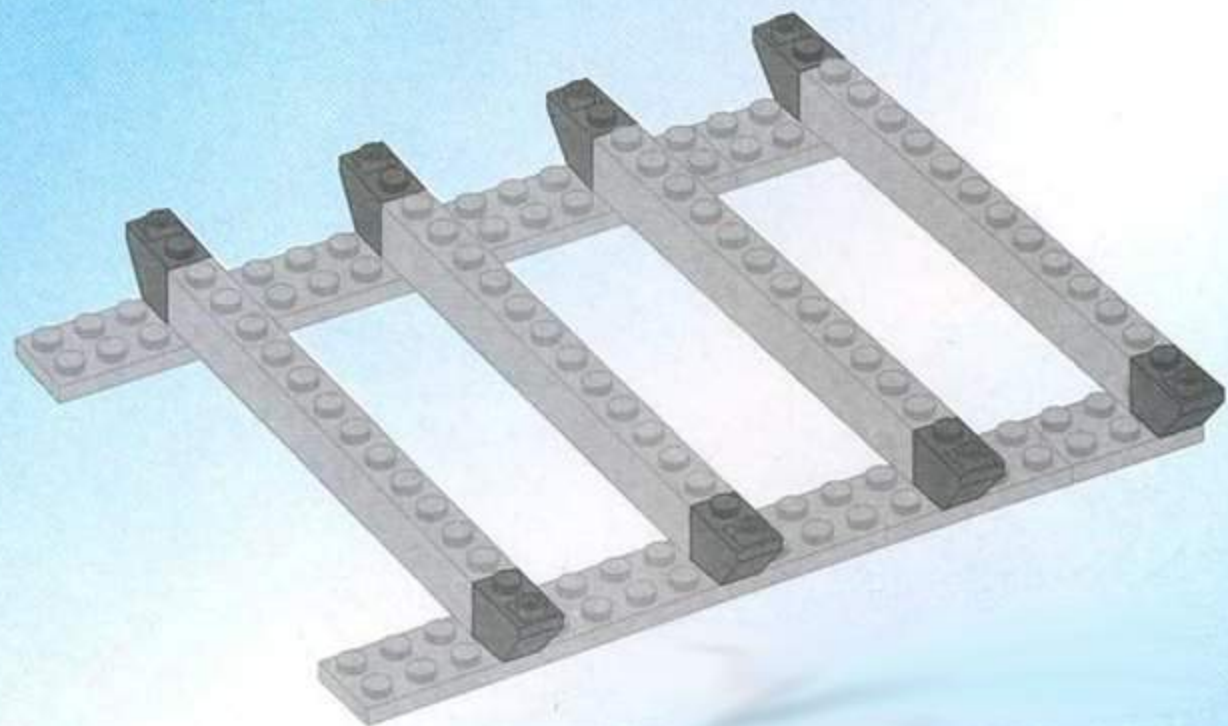
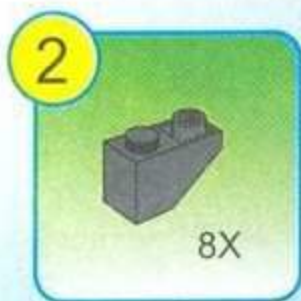
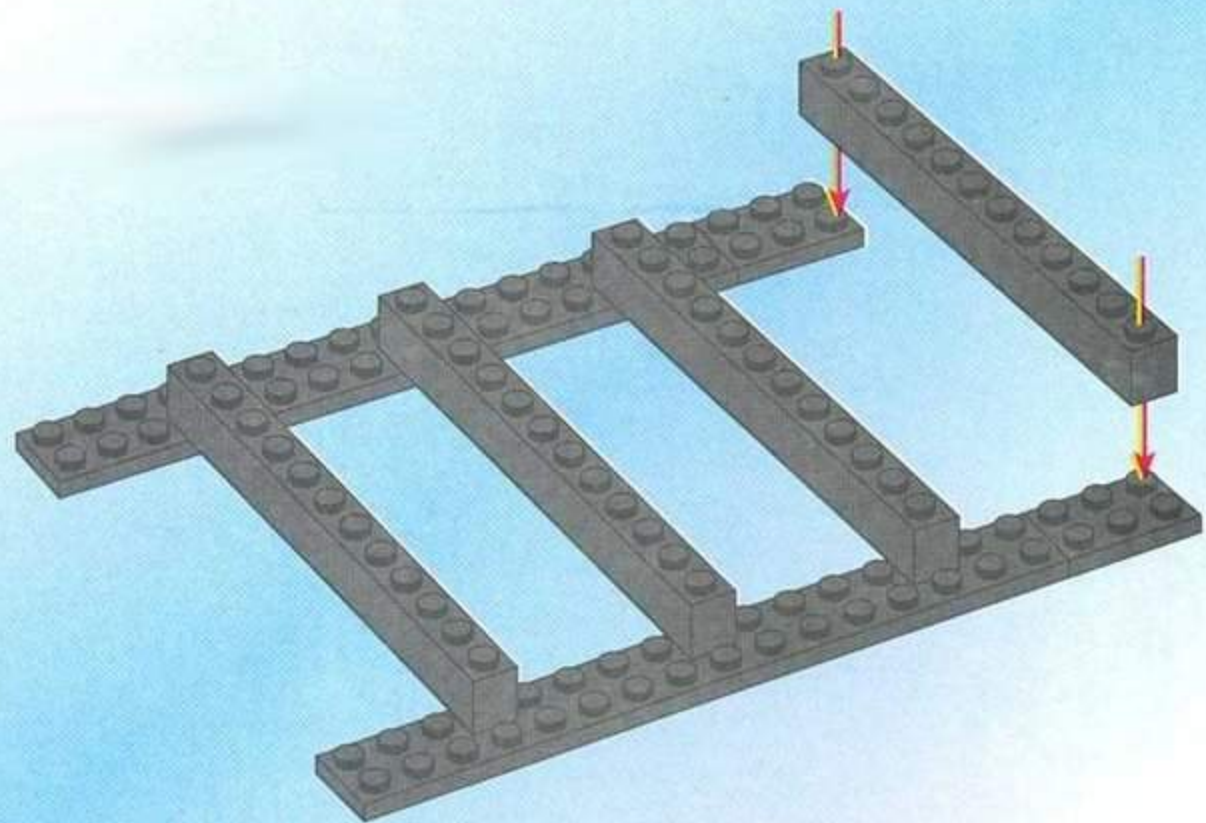
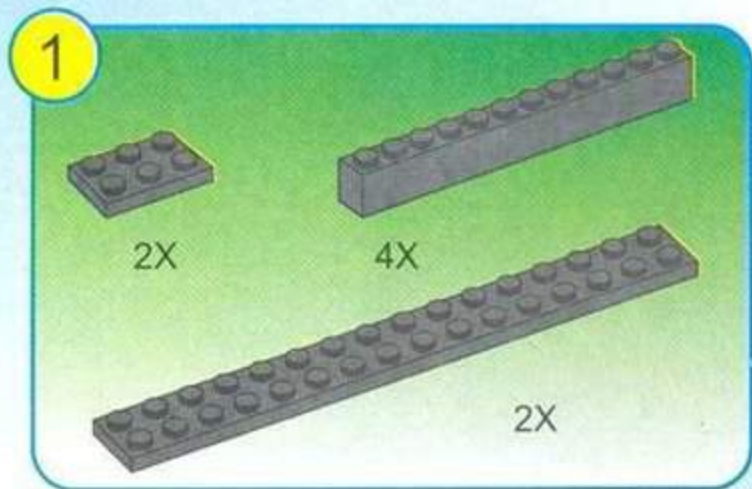

3

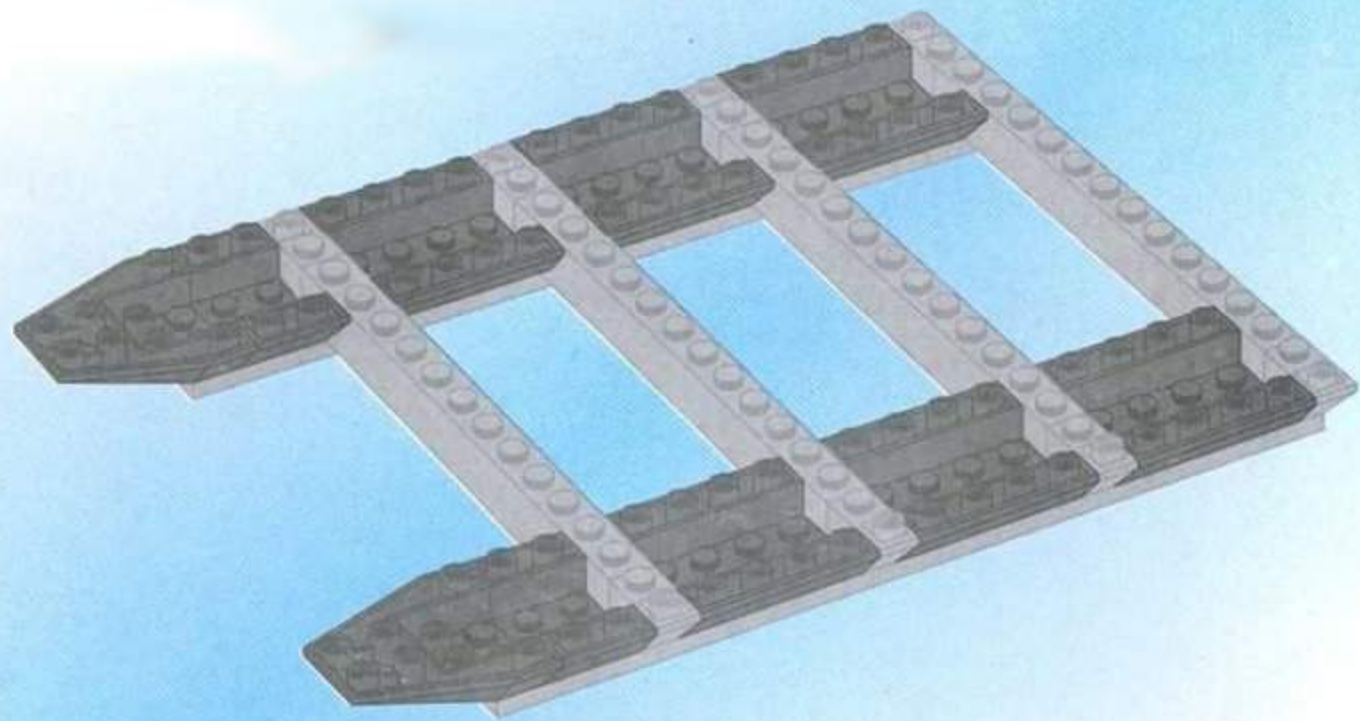

4

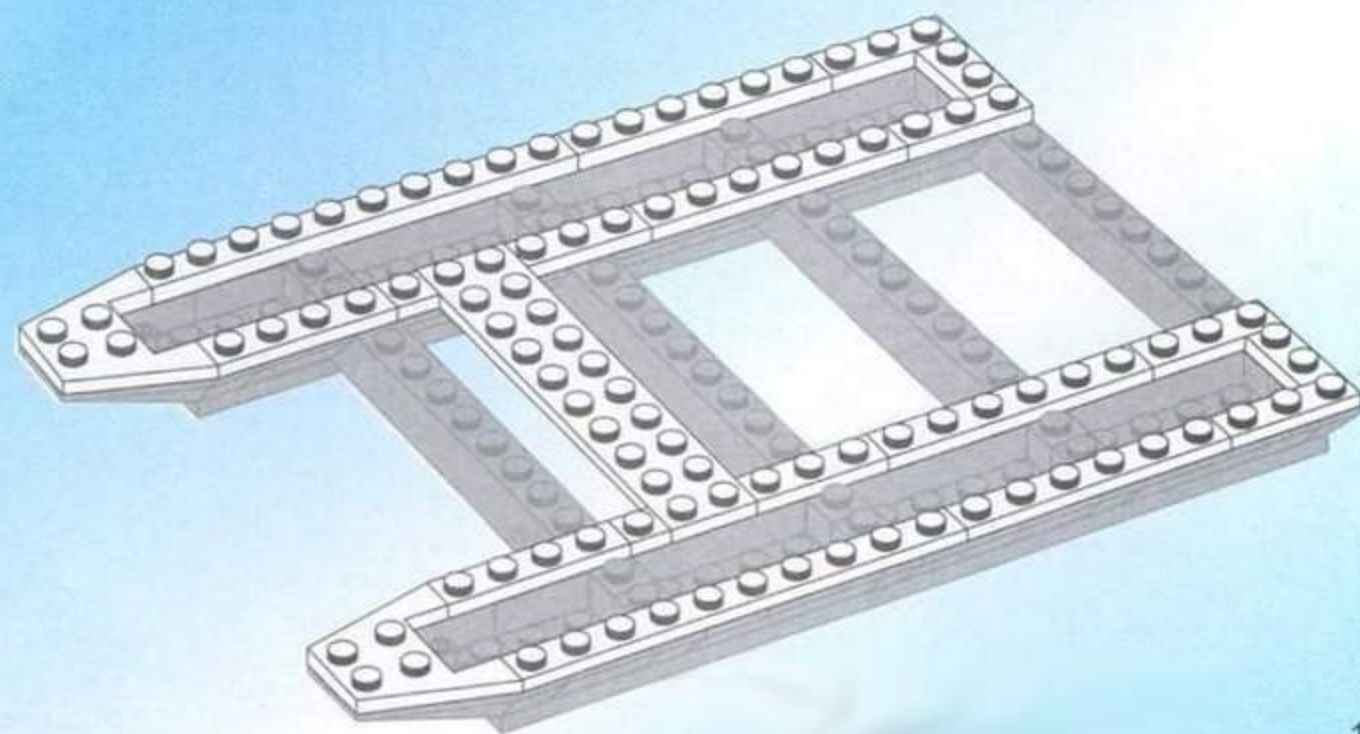
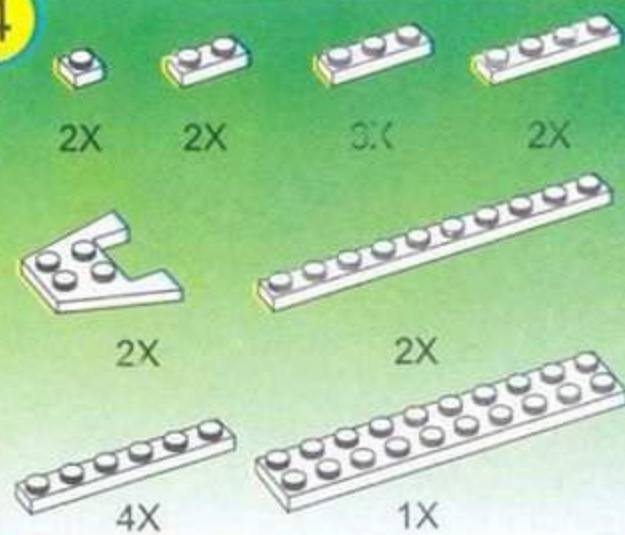

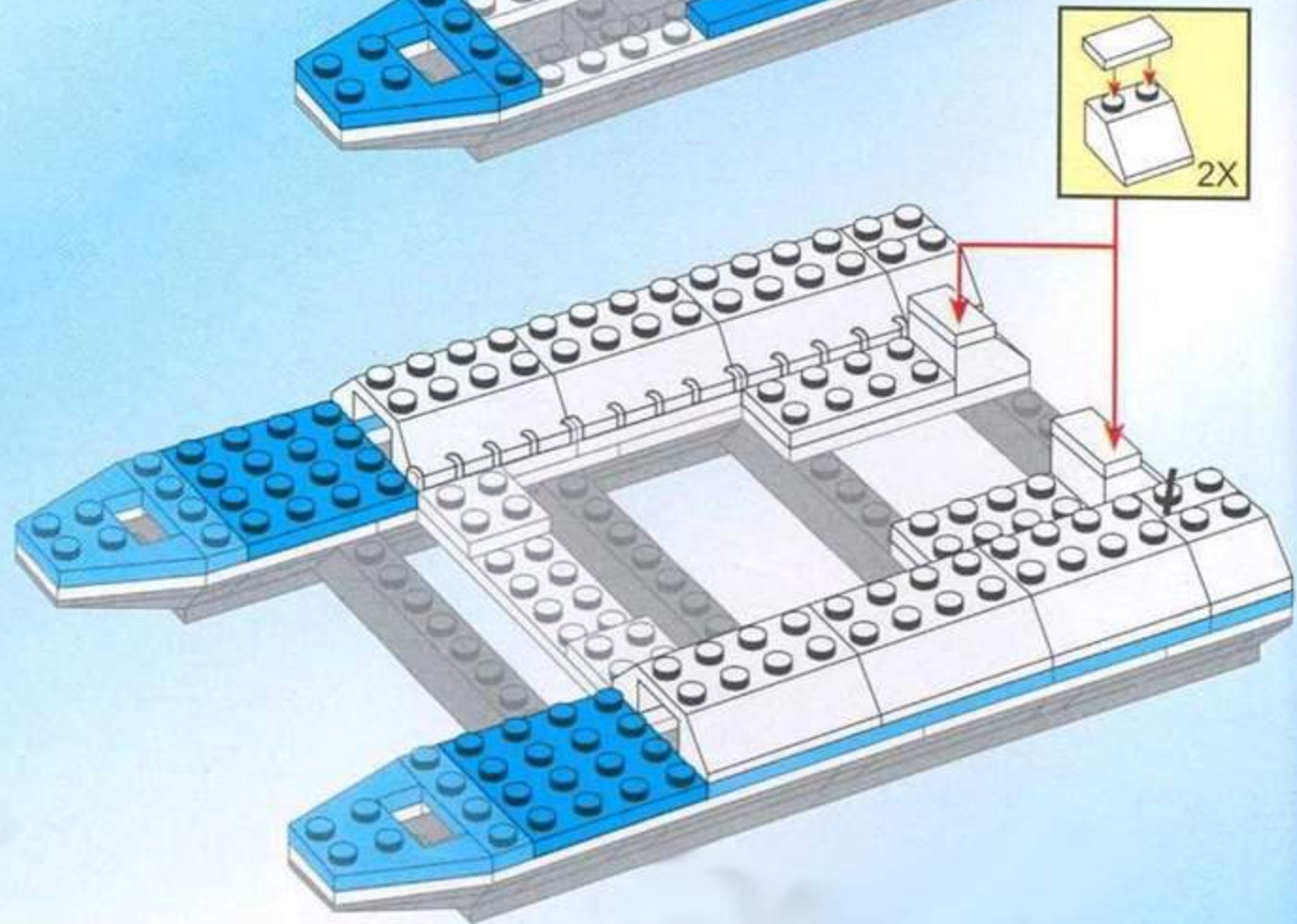
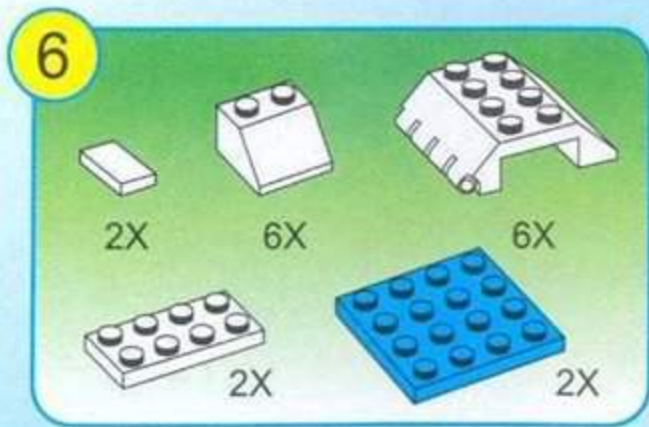
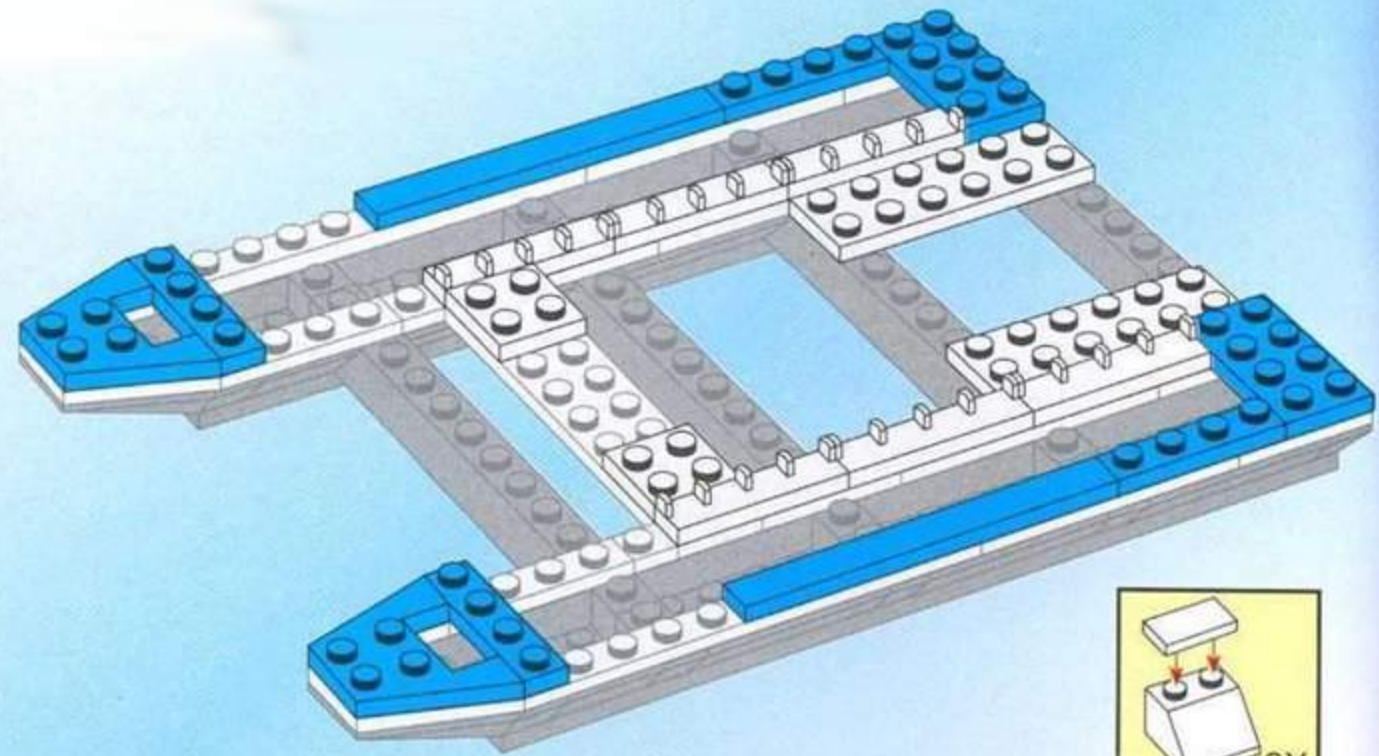
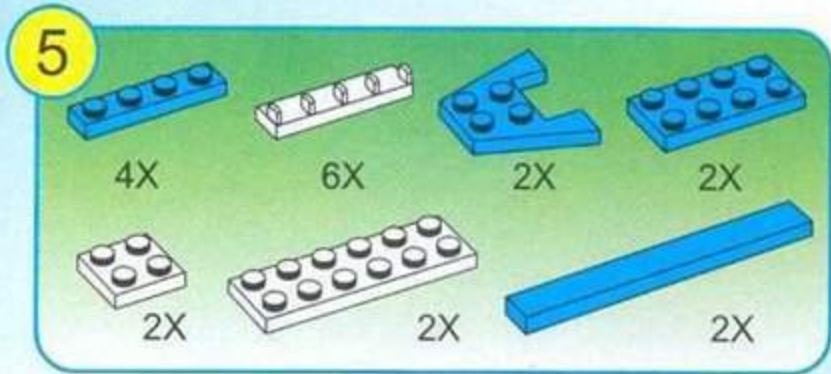

7



4X

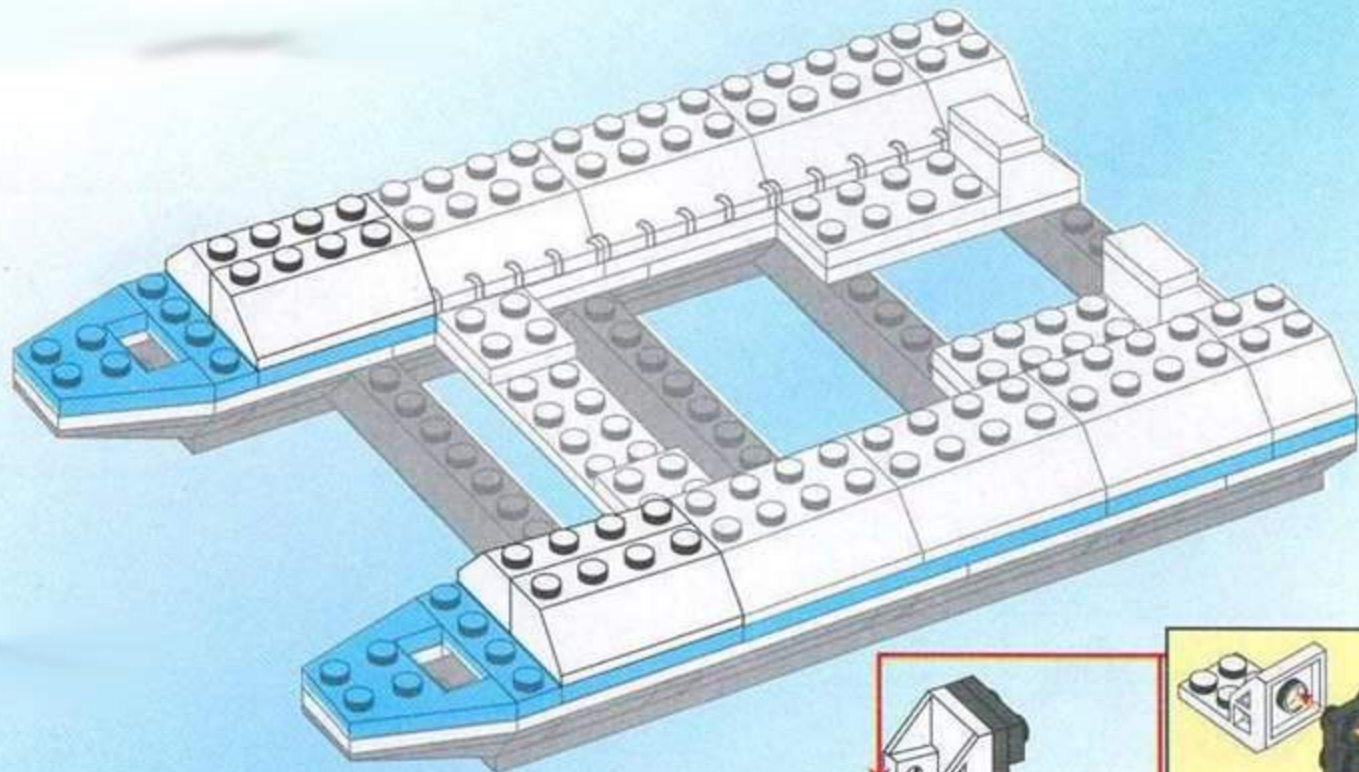

8



4X



2X



2X



2X



2X



2X

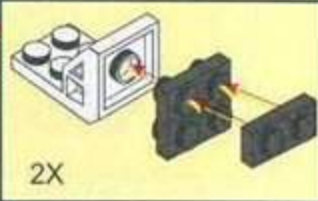
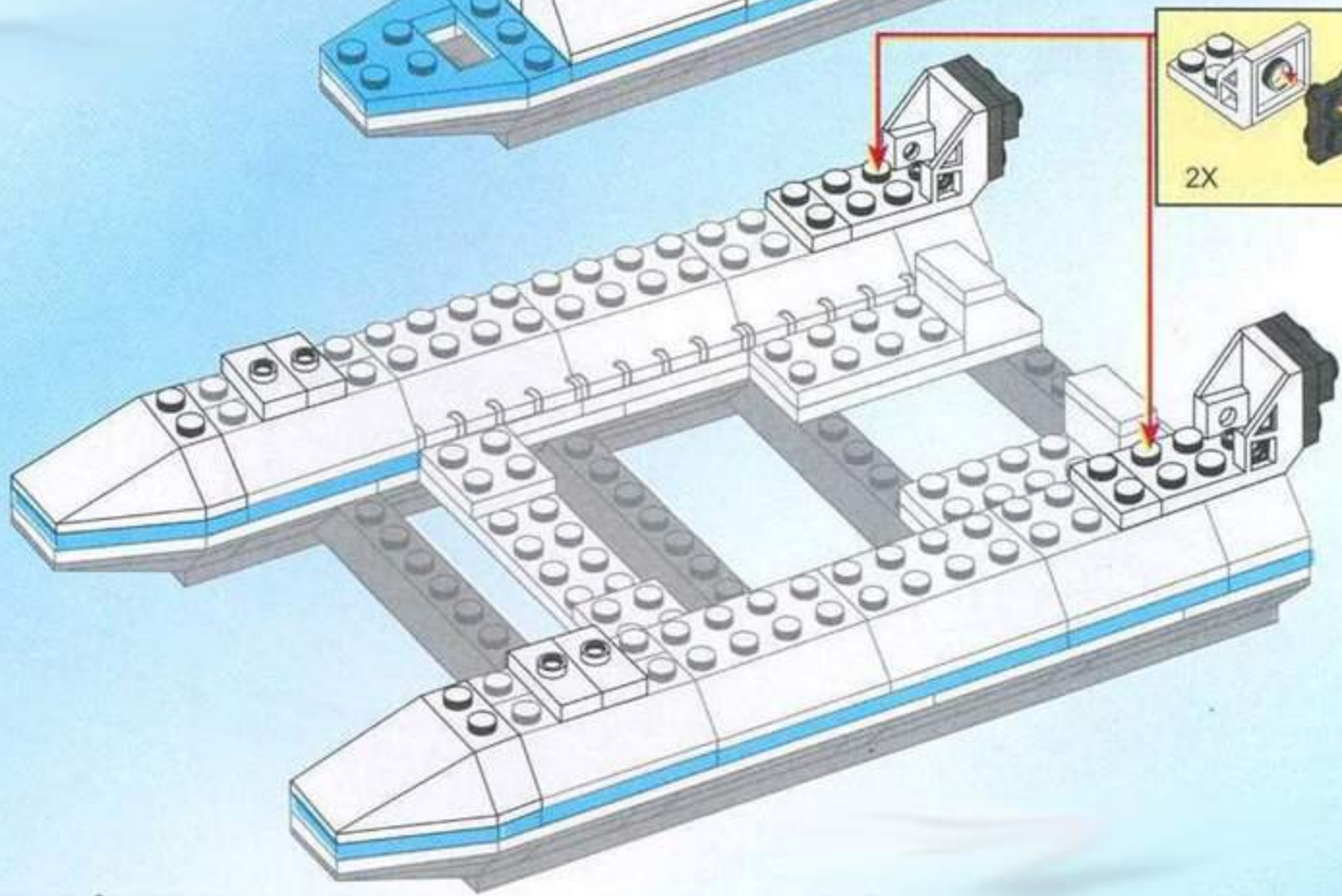

9

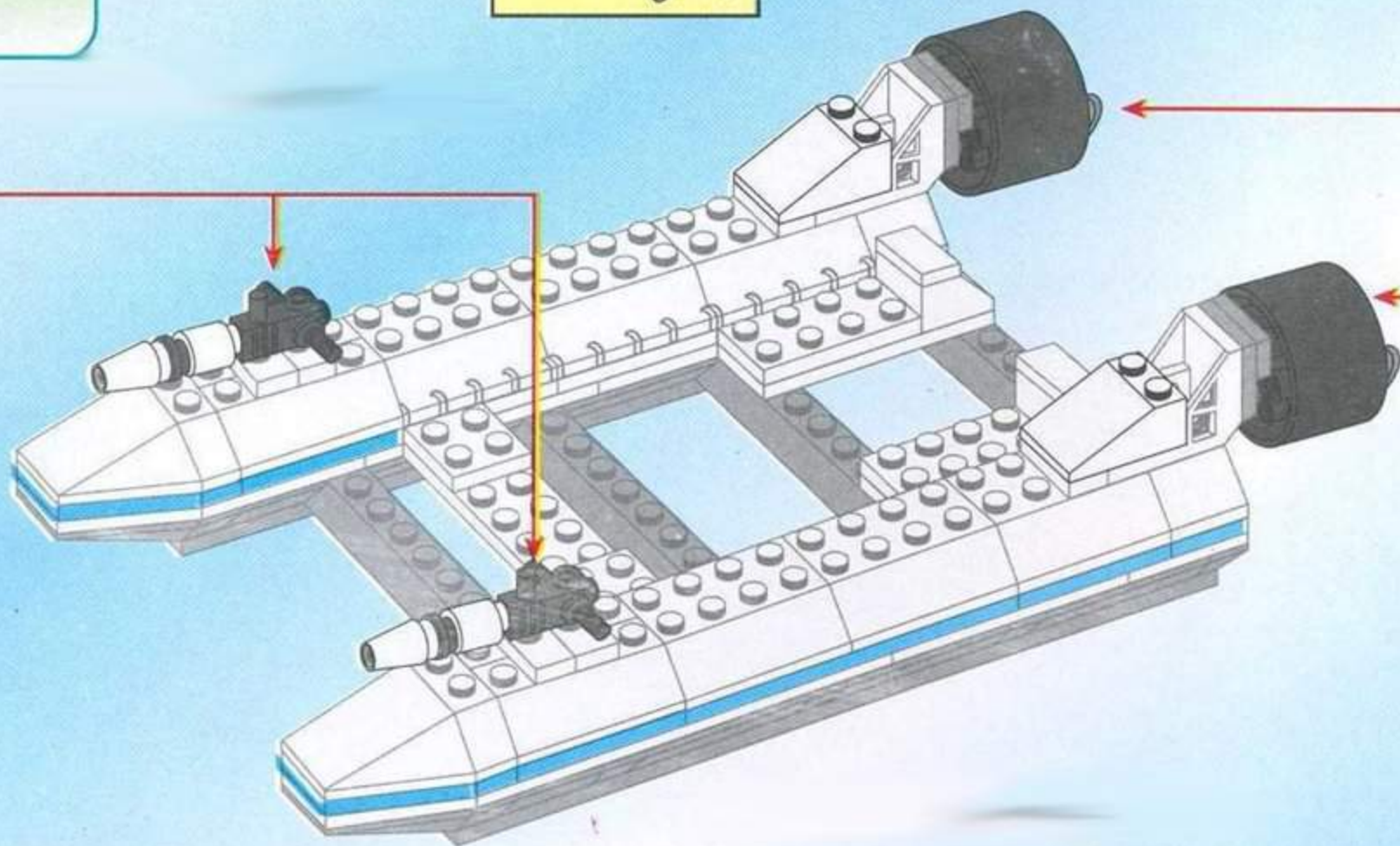
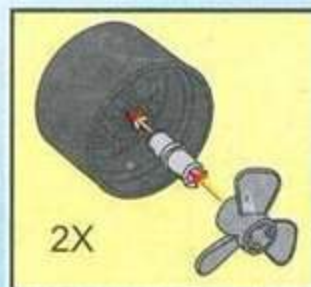
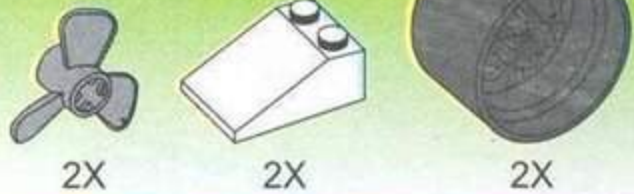

10

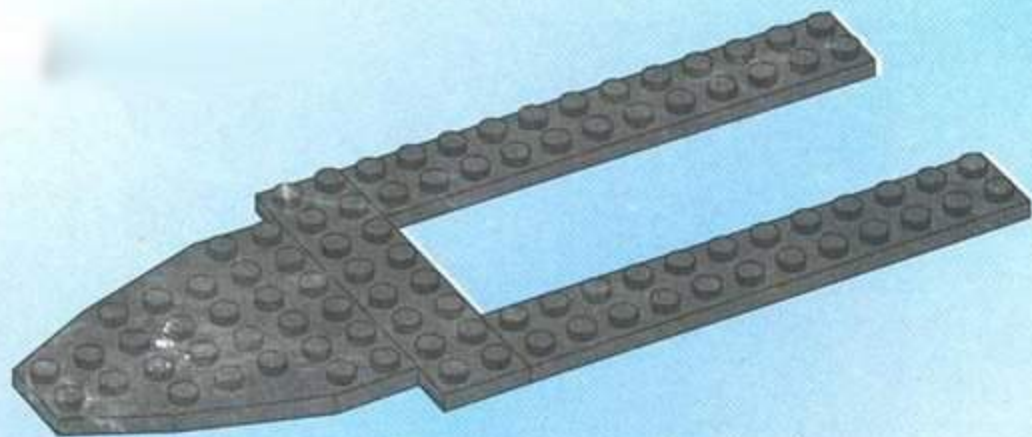
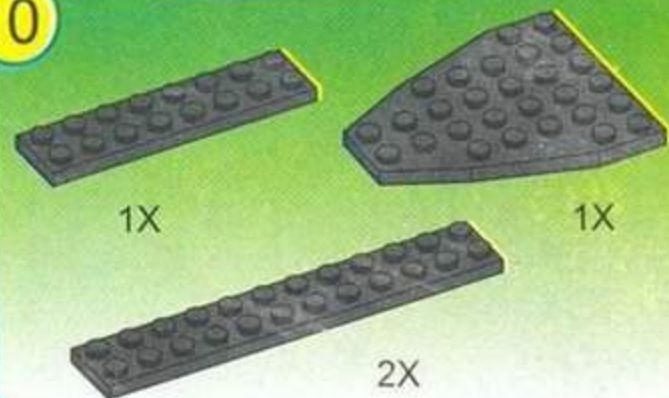

11

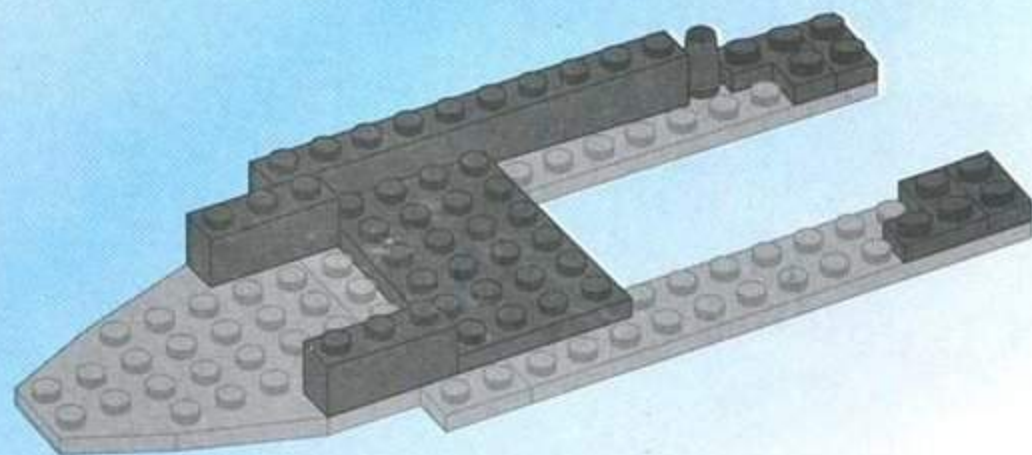
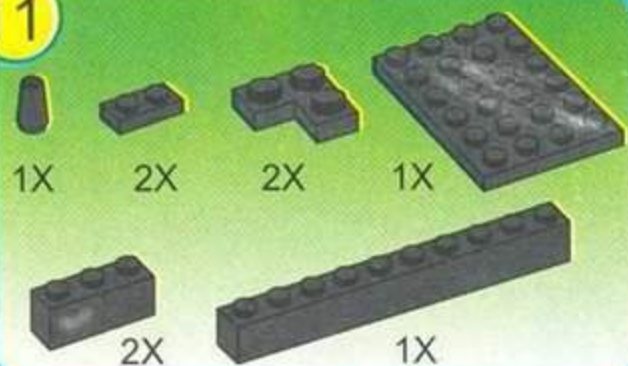

12

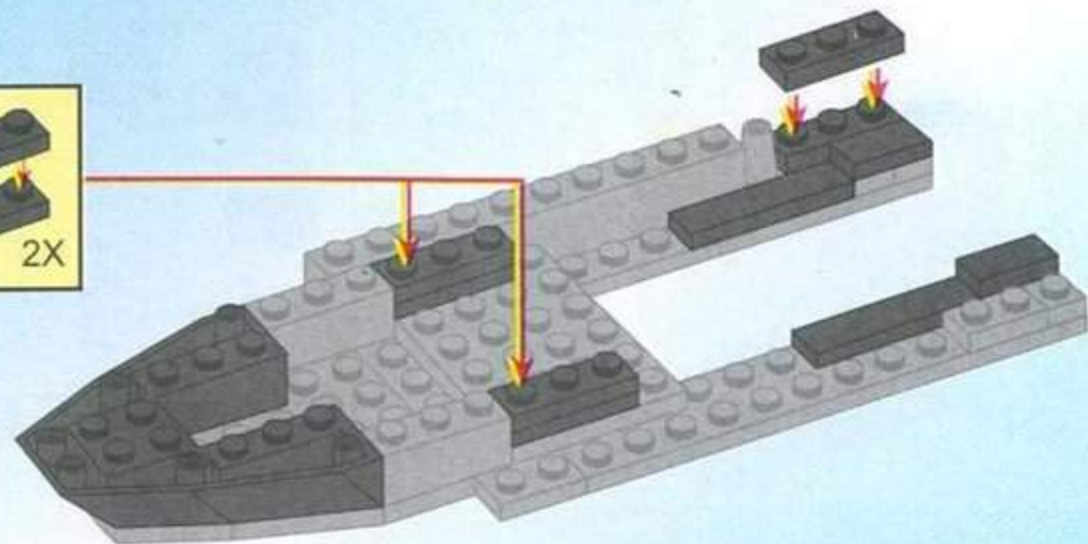
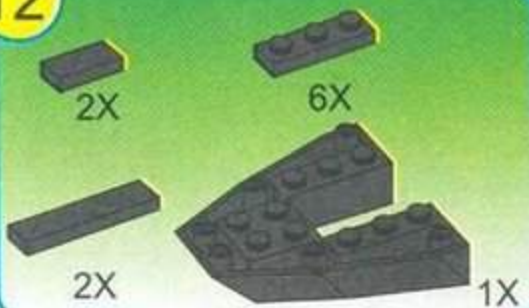

13

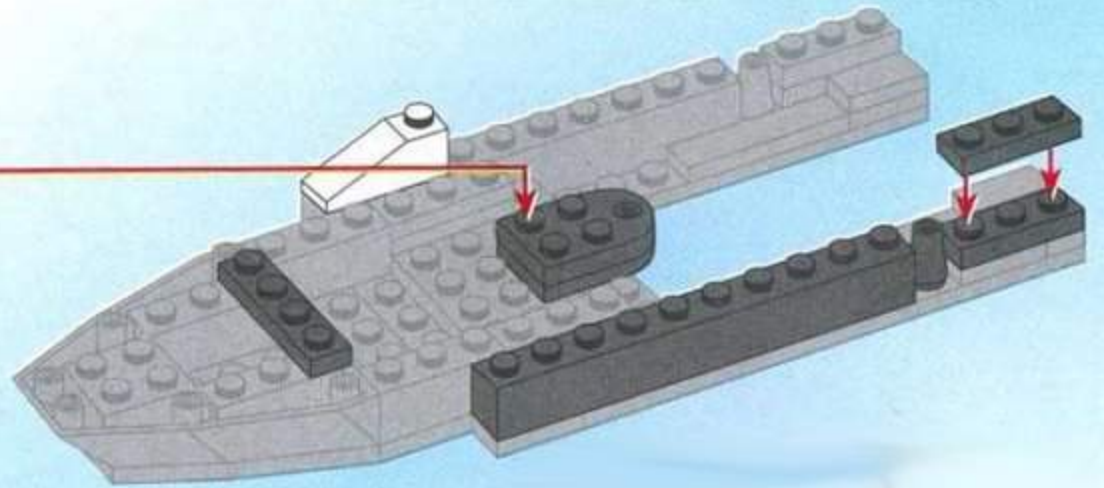
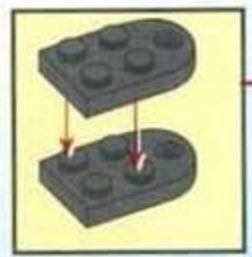
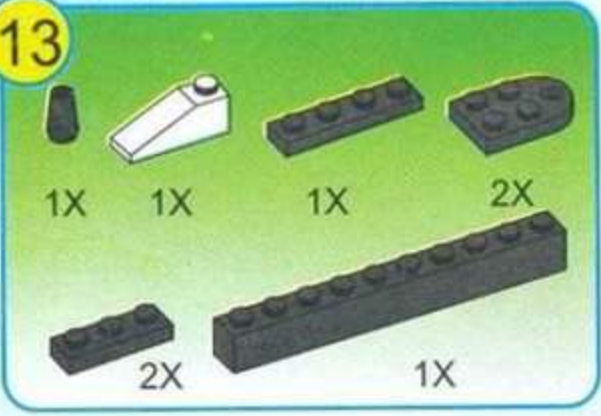

14

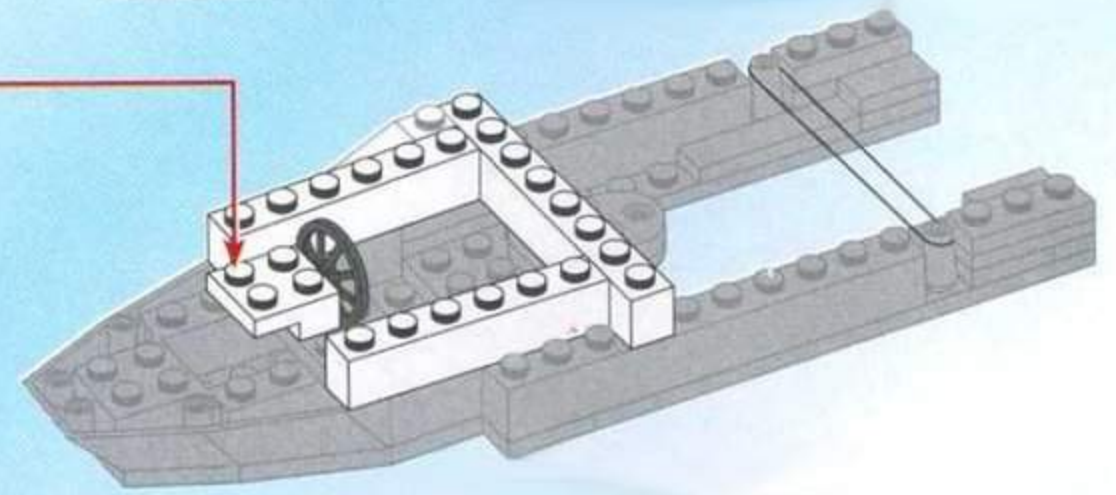
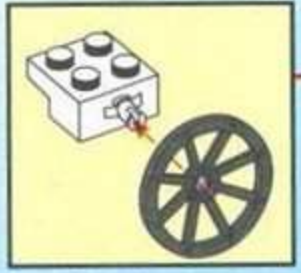
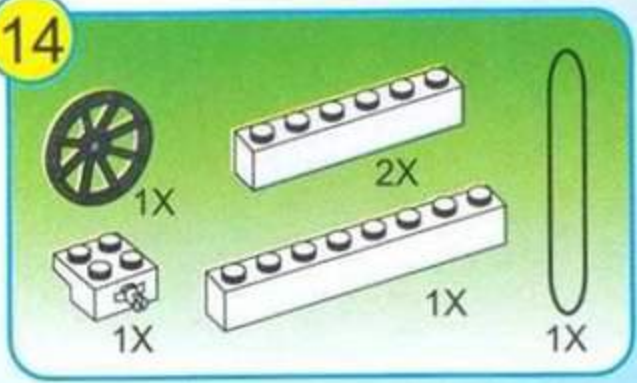

15

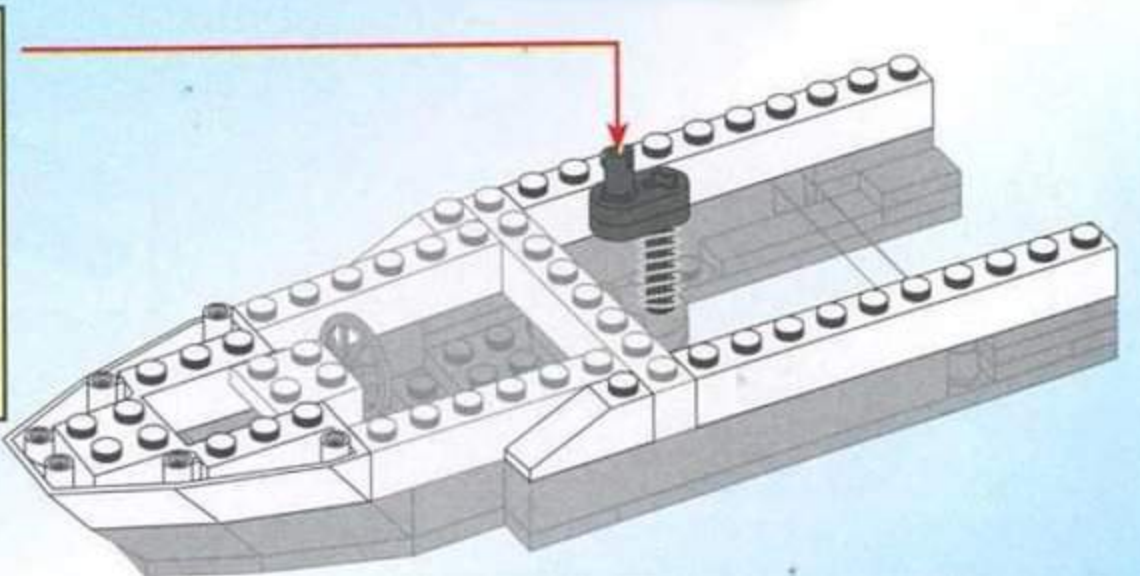
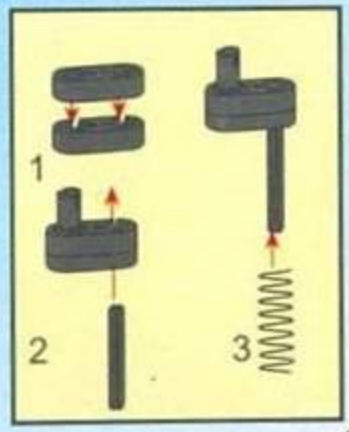
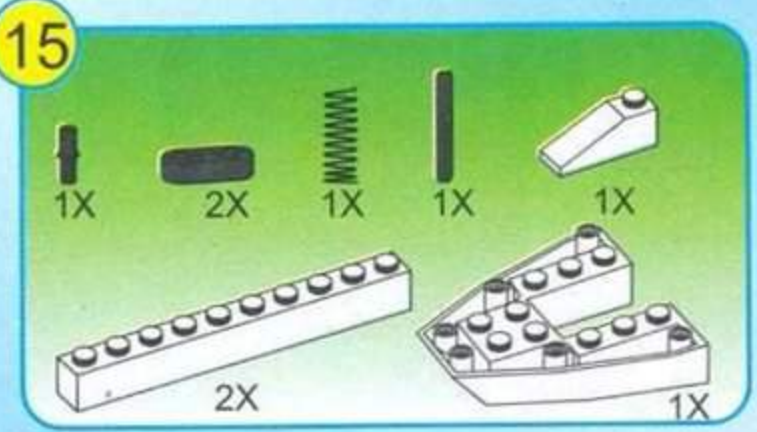

16

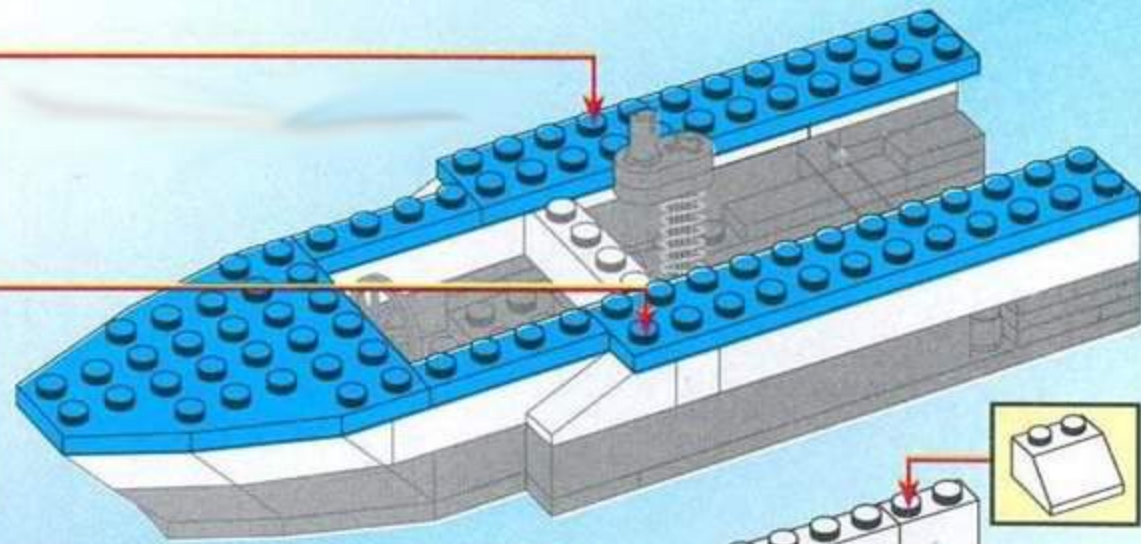
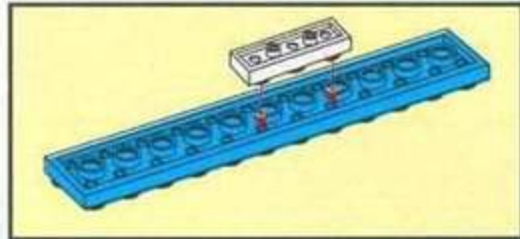
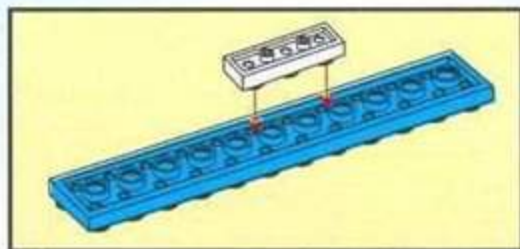
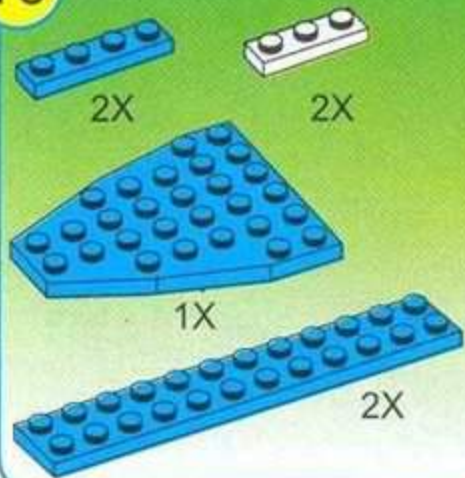

17

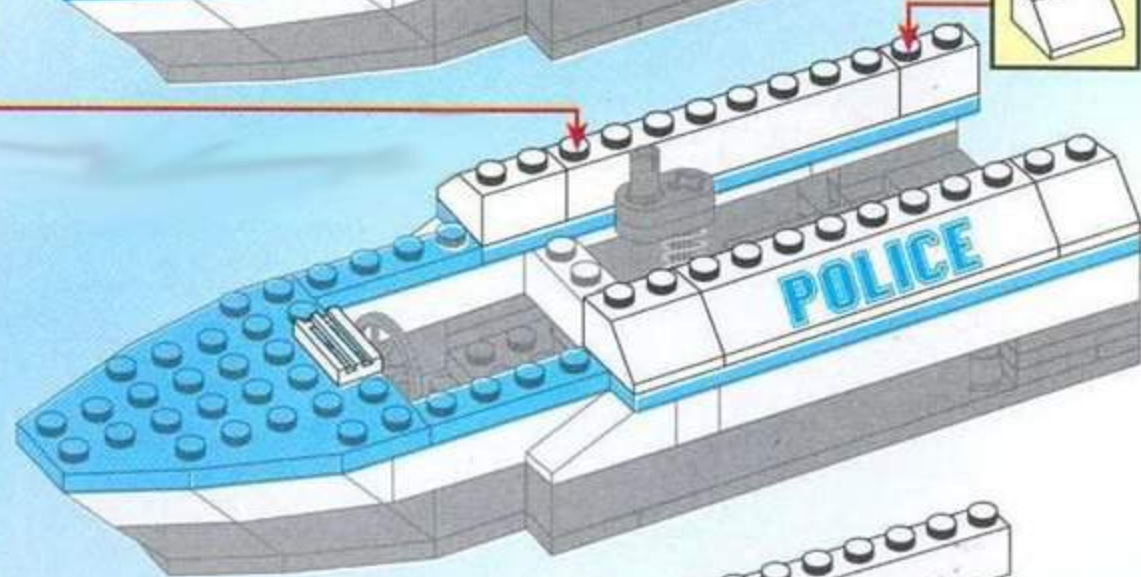
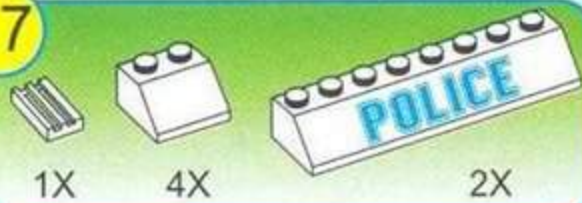

18

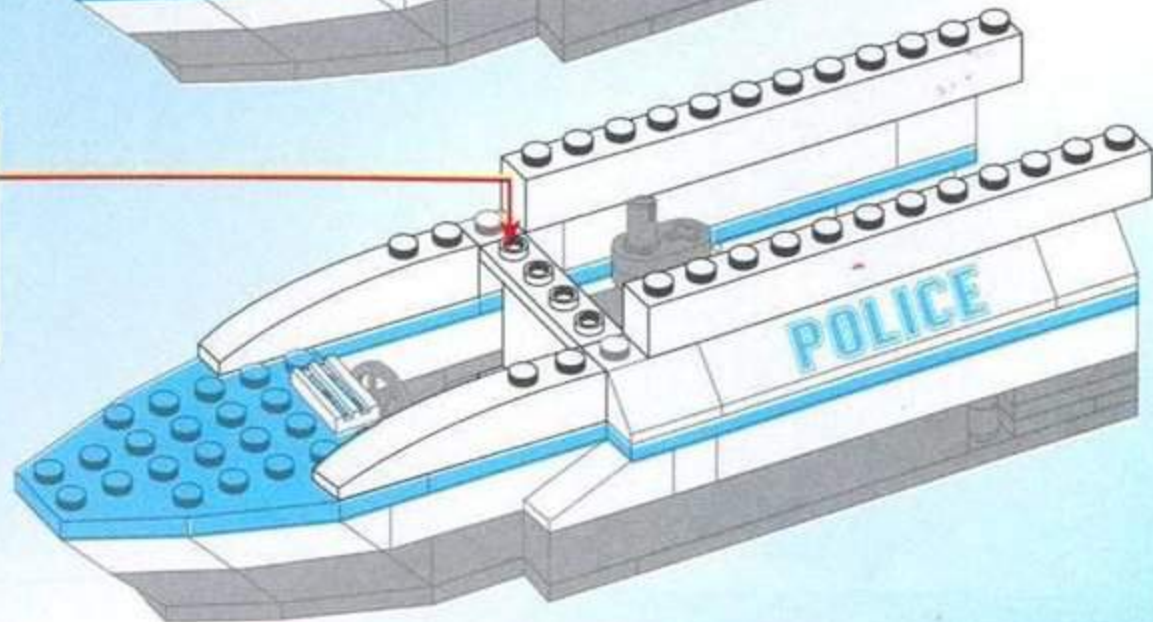
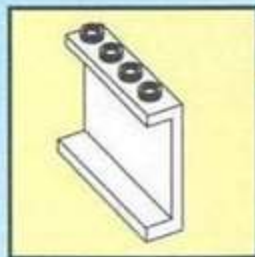
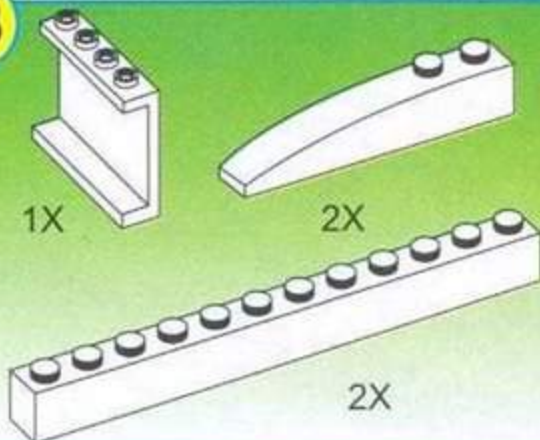

19

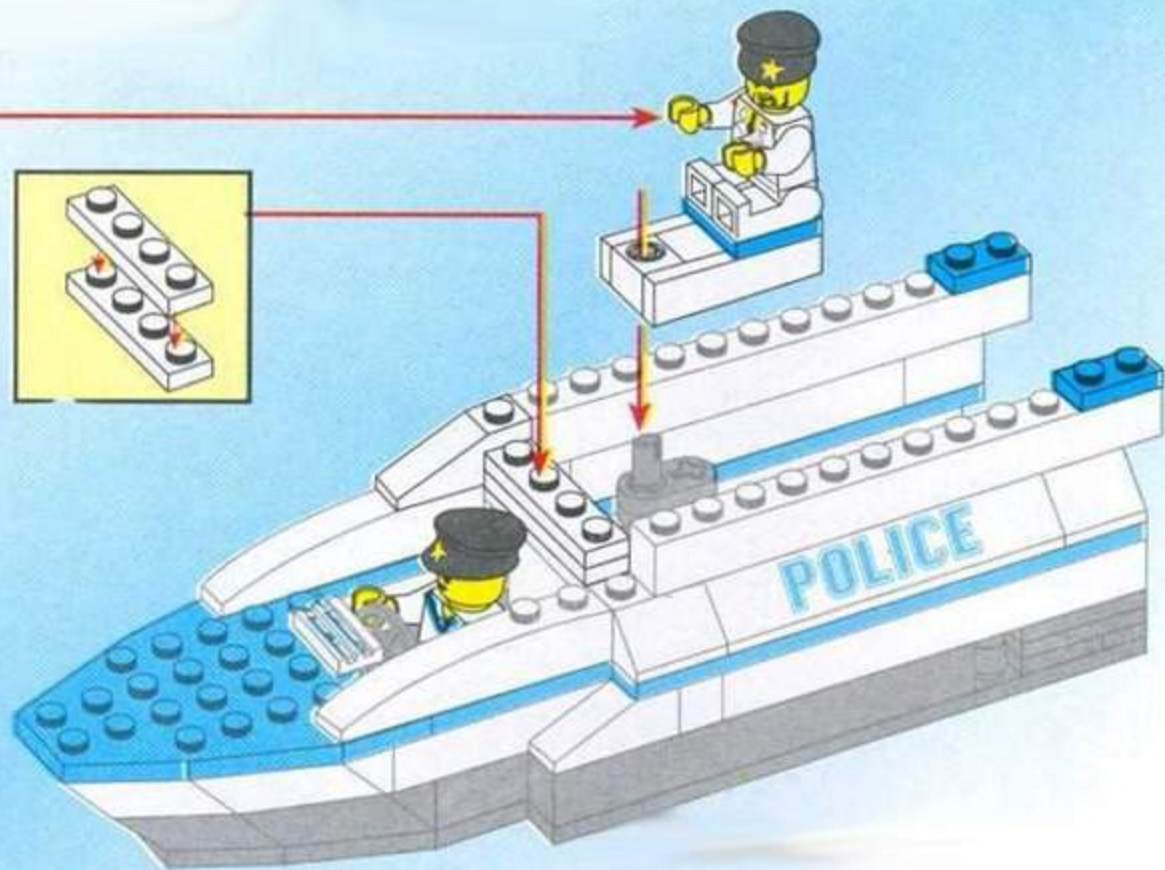
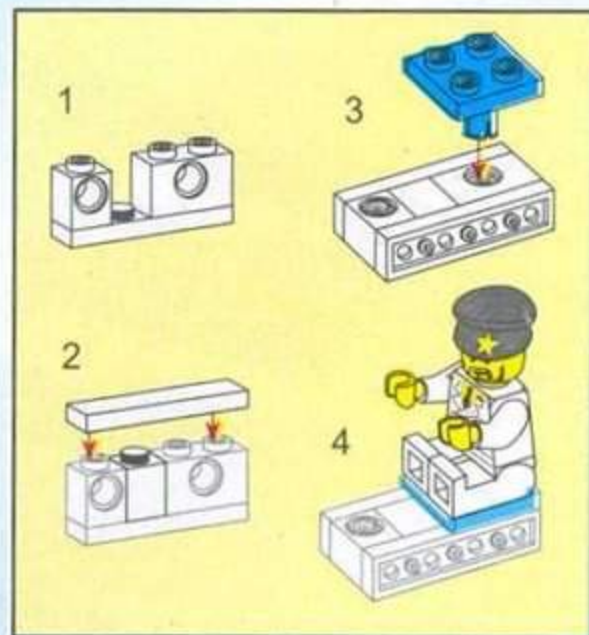
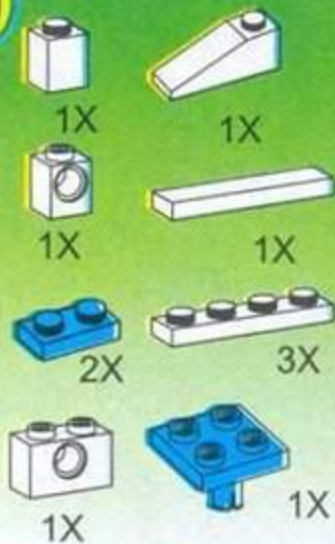

20

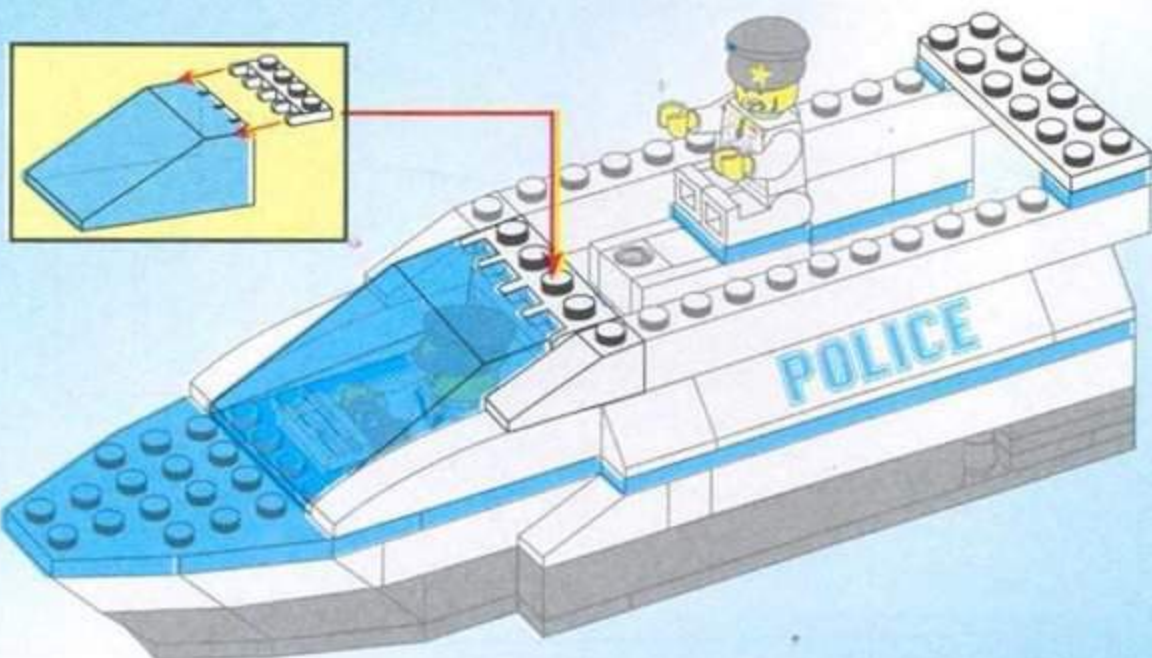
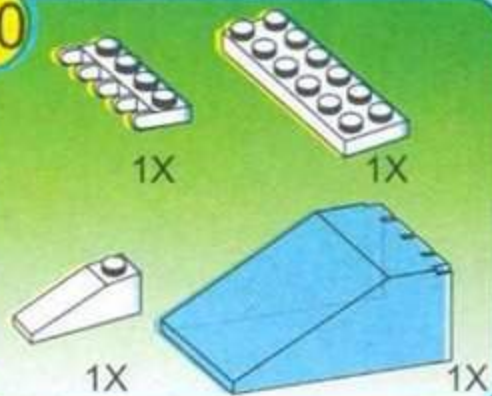

21

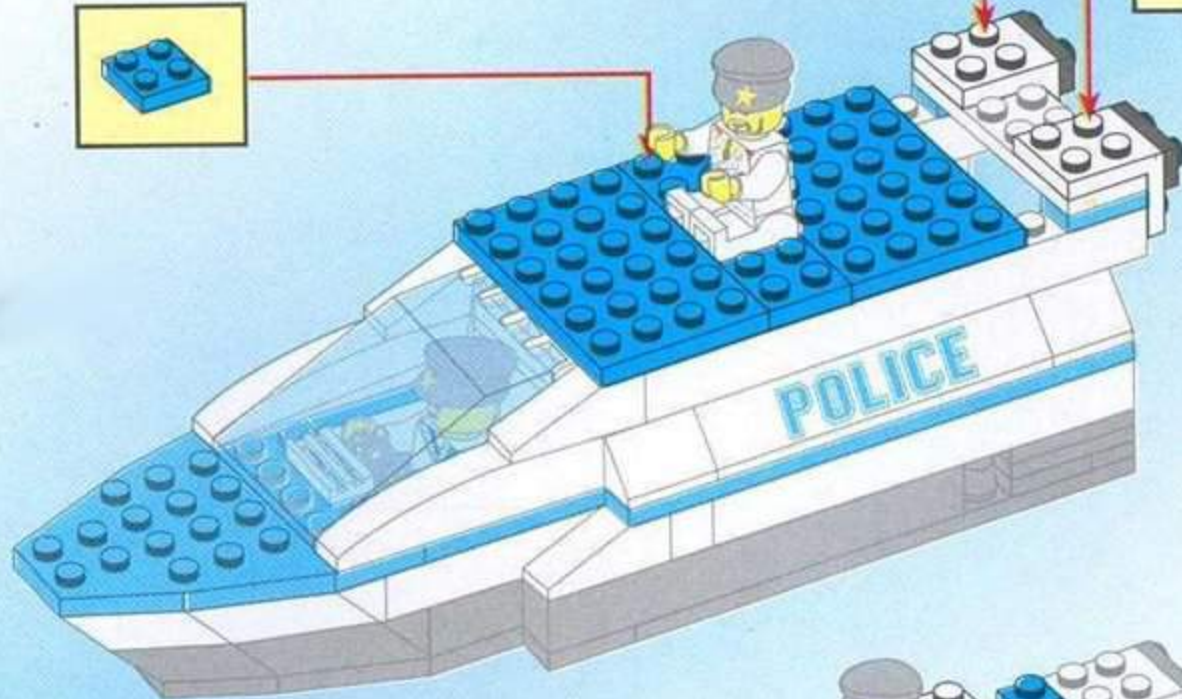
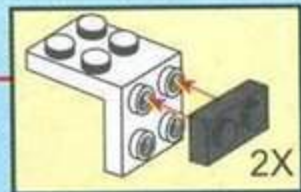
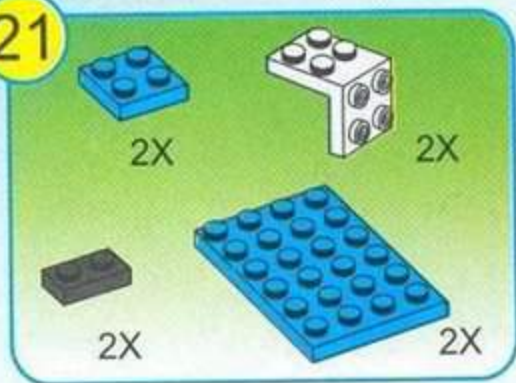

22

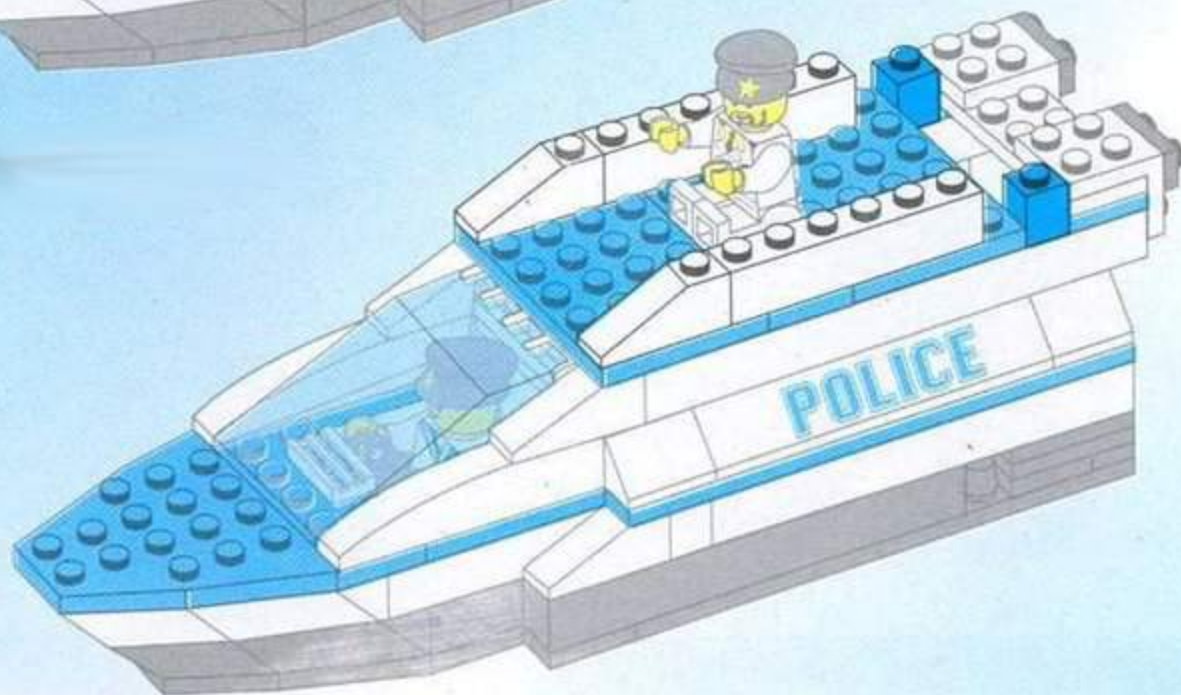
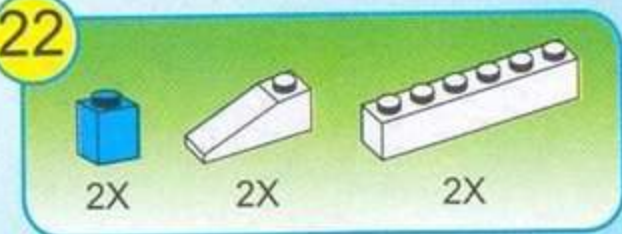

23

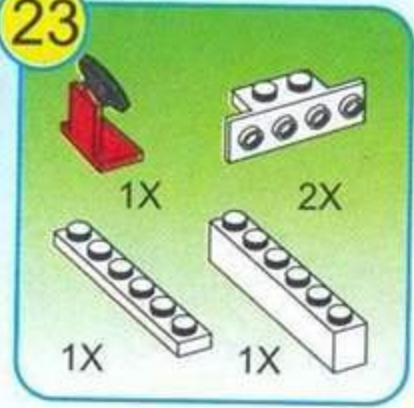

24

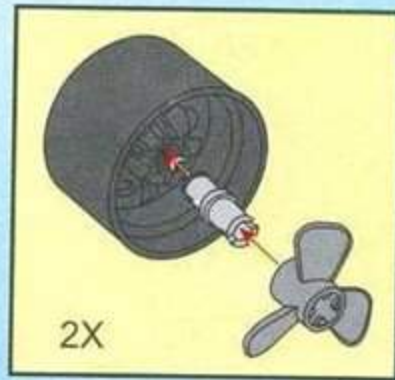
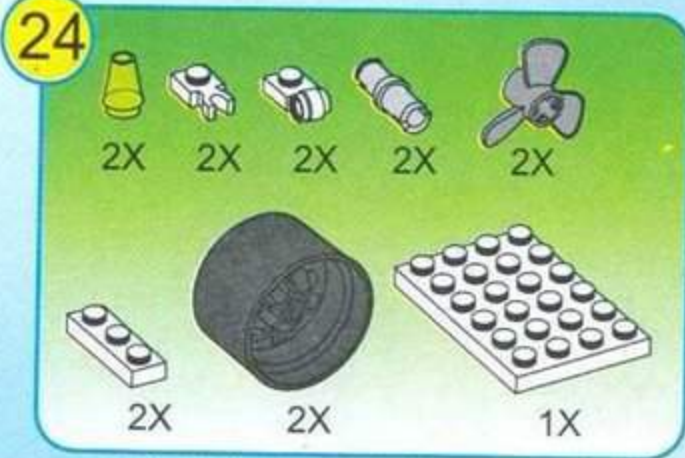

25

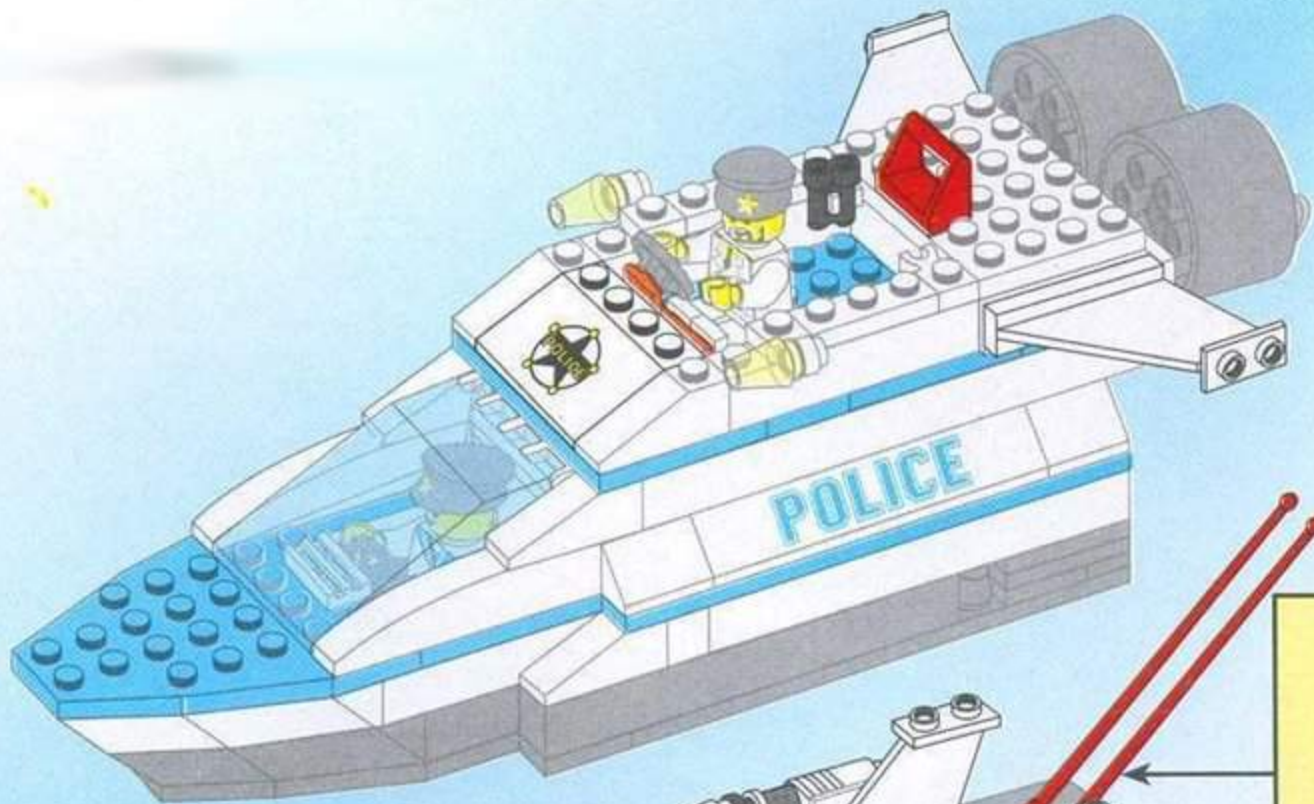
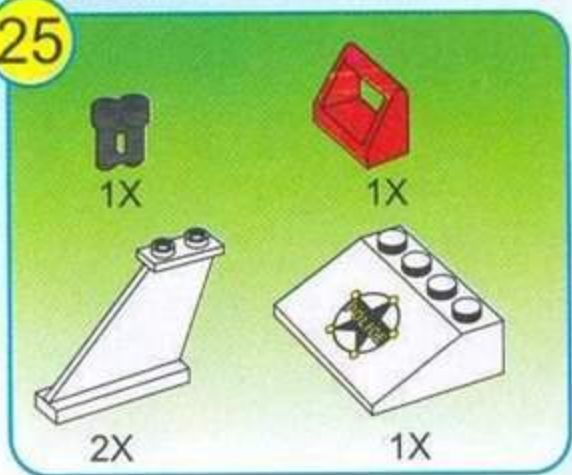

26

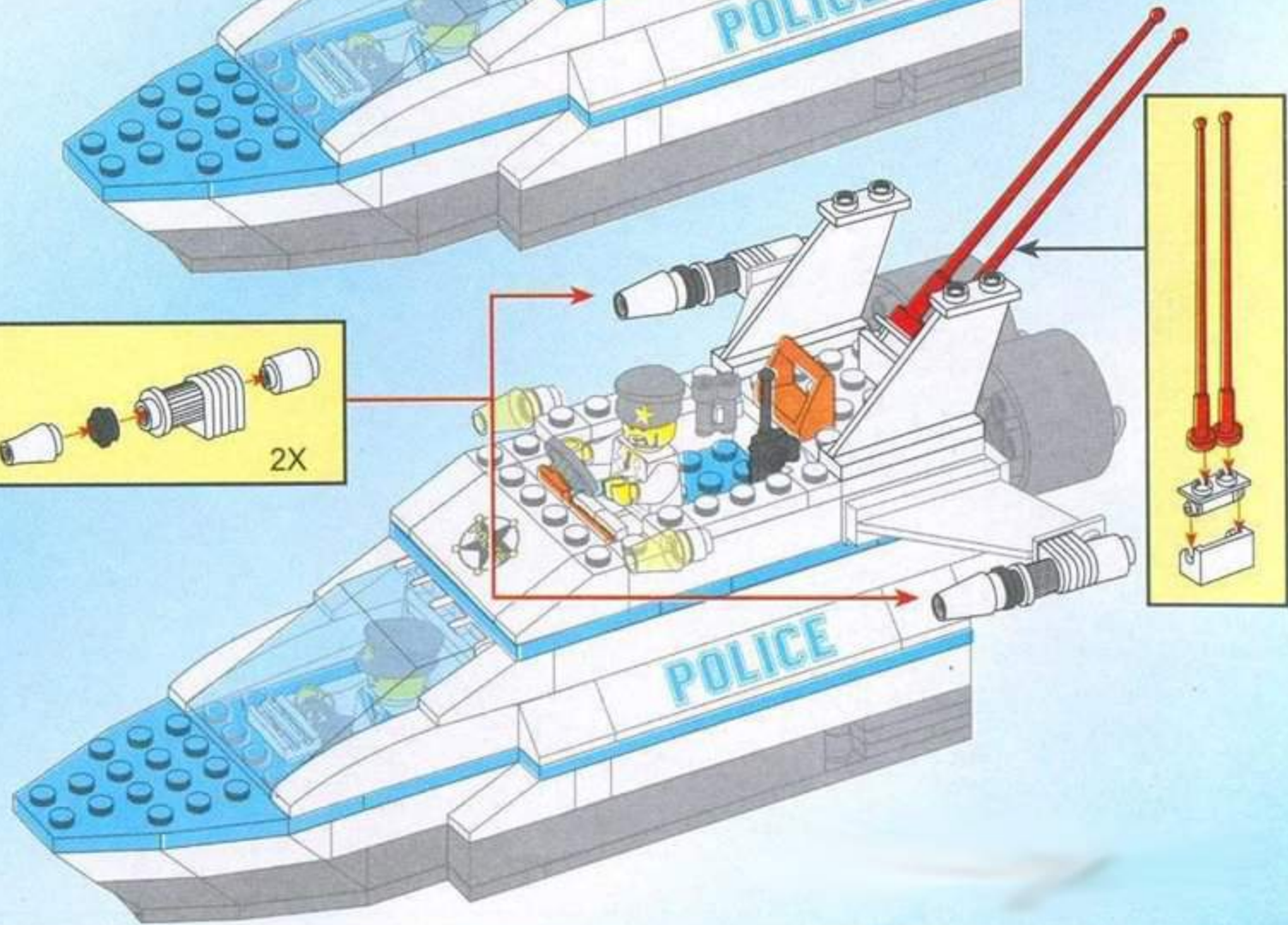
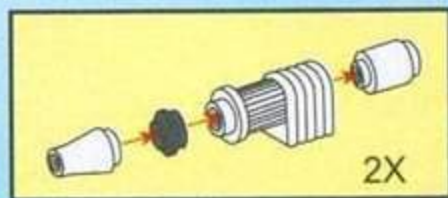

27

2X
2X

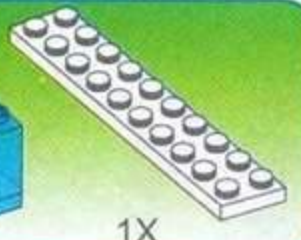

1X

1X

28

4X



4X



4X

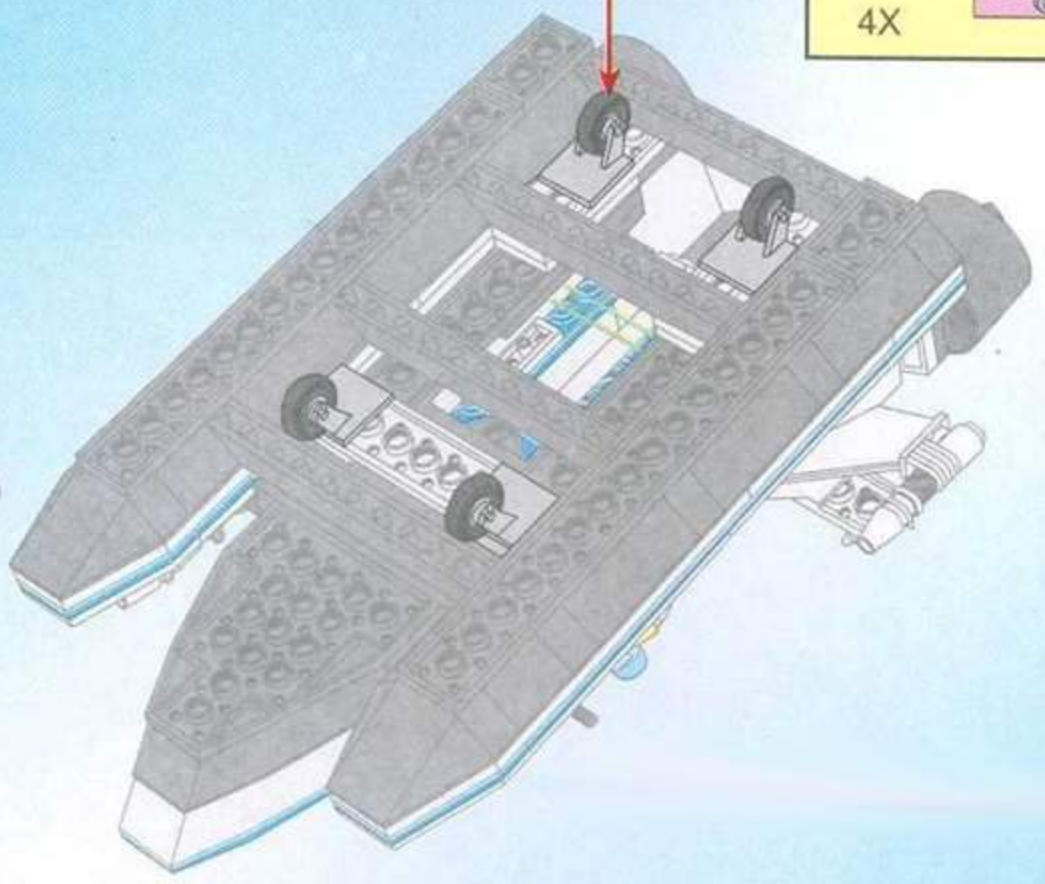
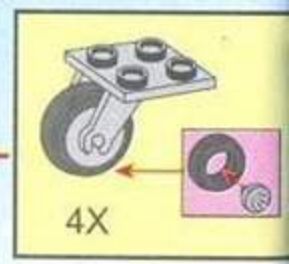
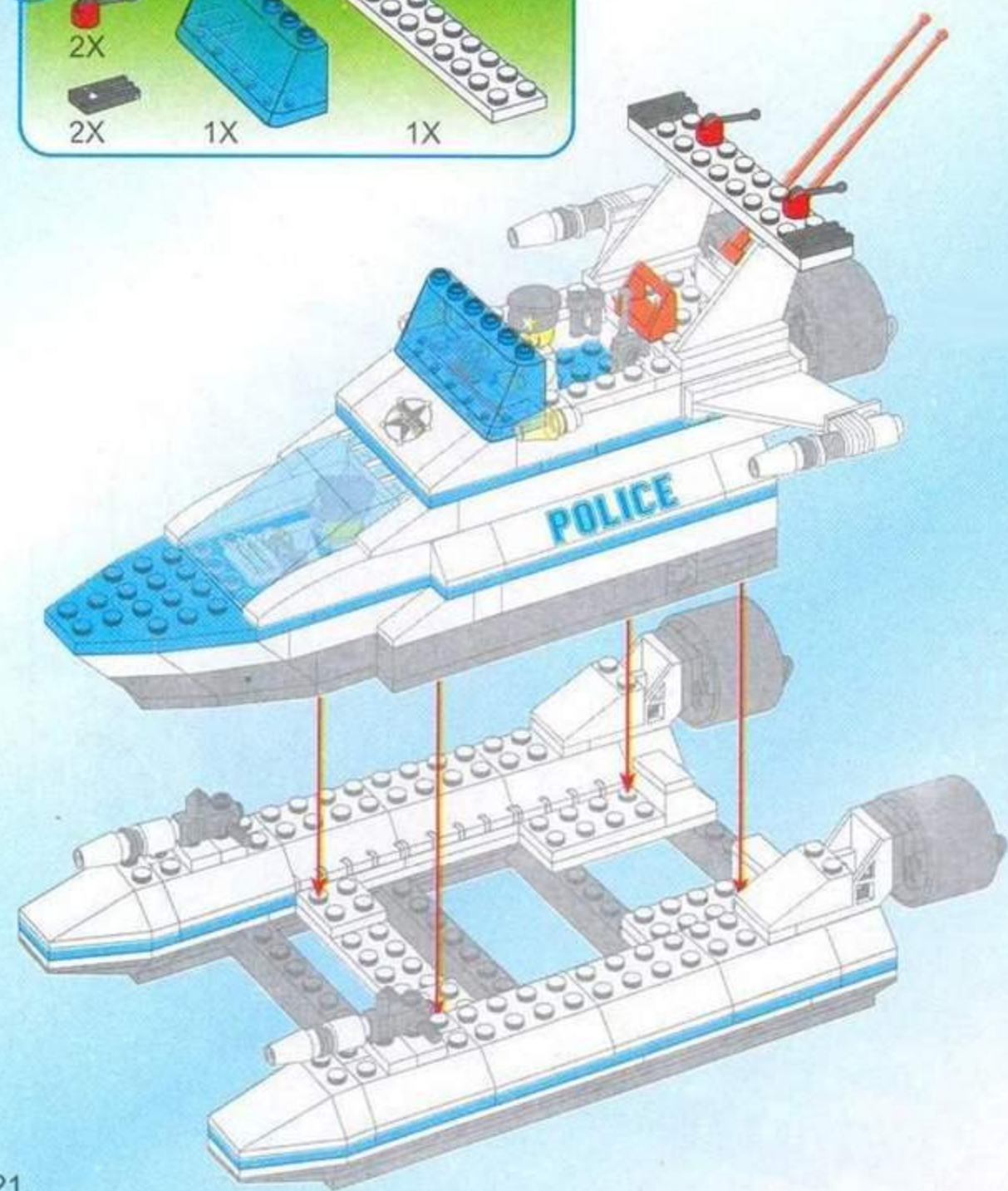

29

